



Catalog
2017



OLMSTED-KIRK

FINE PAPER

Sign Mounting Hardware

Banner Mounting Hardware

Adhesive Products

Media Racks

Banner/Media Display Stands

Shop Tools / Supplies

Vehicle Wrap Tools

Cutting Tools & Blades

TABLE OF CONTENTS

SIGN MOUNTING HARDWARE

SOOPER BRACKETS / SOOPER POLE MOUNT.....	02
PICK N' HOOK / TWIST N' HOOK / 90 SUPER BRACKET TAG-IT BRACKET	
SIGNABRACKET / MAGNABRACKET / SIGN CLIP.....	03
WIND RIDER / SPIDERFEET	
SOOPER HINGE / SOOPER FEET.....	04
4-PAK SOOPER CEILING HOOKS	

BANNER MOUNTING HARDWARE

BANNER TRAK KIT.....	05
TRADE SHOW BANNER BACKDROP KIT	
BANNER TRAK PARTS.....	06
BLACK WALL MOUNT BRACKET KIT.....	07
POLE BANNER SINGLE KIT ALUMINUM 1"	
POLE BANNER DOUBLE KIT ALUMINUM 1"	
1" ALUMINUM POLE BANNER PARTS	
POLE BANNER SINGLE KIT ALUMINUM 1.66".....	08
POLE BANNER DOUBLE KIT ALUMINUM 1.66"	
1.66" ALUMINUM POLE BANNER PARTS	
REPLACEMENT POLES	
POLE BANNER SINGLE KIT FIBER-GLASS.....	09
POLE BANNER DOUBLE KIT FIBER-GLASS	
FIBER-GLASS POLE BANNER SPARE PARTS	
QUICK RELEASE STAINLESS STEEL STRAPS & CABLE TIES UV	
LINKLIP / LINKLAMP / SIBOLT.....	10

ADHESIVE PRODUCTS

BANNER BOND / BANNER BOND ULTRA.....	11
SOOPER STRONG HOOK & LOOP	
GENERAL PURPOSE MASKING TAPE	
MEGA TAPE / POLE TAPE	
POWER TABS / POWER TAPE.....	12
MEGA TAPE / POLE TAPE / BRAVO TABS.....	13
POWER CLIPS / POLY TABS / POWER PUNCH	

MEDIA RACKS

MONDO RAXX KIT.....	14
MONDO RAXX JUMBO MEDIA STORAGE	
MONDO RAXX JUMBO BANNER MATERIAL STORAGE	
MOBILE RACK 16 ROLLS	
MOBILE RACK 12 SPINDLES 2" CORE.....	15
MOBILE RACK 16 SPINDLES 3"	
FLOOR RACK HD 44 ROLLS 3" CORE	
WALL RACK HD 20 ROLLS 3" CORE	
SOOPER CLIP / Z-TRAPS / CORE ID CARDS.....	16
GRAPHIC GLOVES	
LOW COST MEDIA HANDLING GLOVES / WRAP GLOVES	

BANNER / MEDIA DISPLAY STANDS

THE ULTIMATE BANNER STAND.....	17
MAXI POD BANNER STAND	
1" QUICK RELEASE CLAMP	

SHOP TOOLS / SUPPLIES

MANO HAND GROMMET PRESS / DIES.....	18
PLASTIC GROMMETS / BRAVO AIRE GROMMET PRESS	
PLASTIC GROMMET SIZE GUIDE	
SOOPER ACE GROMMET PRESS / DIES.....	19
METAL GROMMETS / ECONO AIR GROMMET PRESS	
DIES / METAL GROMMET SIZE GUIDE	
CLEAR GROMMETS COMBO KITS / DIES / MANO COMBO KIT... 20	
SOOPER ROUNDER / DIES / XPRT COMBO KIT.....	21
XPRT CORNER ROUNDER KIT / XPRT HOLE PUNCH KIT	
SOOPER EDGE SAFETY RULER.....	22
THE BIG BLUE SAFETY RULER / RULER ACCESSORIES	

X-TREME HD ALUMINUM STRAIGHT EDGE.....	23
"FOUR PACK" RULERS / DESIGNER'S LAYOUT RULERS	
X-TREME STAINLESS STEEL RULERS	
COMPLETE WEEDING KIT	
WEEDING PEN / RETRACTABLE WEEDING TOOLS.....	24
PRO-ROLL TAPE APPLICATOR	
TABLE FRAMES.....	25
MOBILE MULTI USE TABLE FRAME.....	26
XTREME CUTTING MATS	
SOFT GRIP 8" SCISSORS / YARD STICK COMPASS CUTTER.. 27	
CRAFT & HOBBY TOOL GYRO-CUT	
THE YELLOW-BLACK TOOL POUCH	
THE MAGNET TOOL POUCH	
ALUMALITE SQUEEGEES / ALUMALITE HD LINER CUTTER.....	28
ALUMALITE THREADED HANDLE.....	29
THE G-N-G SQUEEGEE	
SPINNING ORGANIZERS / 3M TAPE DISPENSER.....	30
ROLLER SQUEEGEE BRAYERS	
SOOPER TACK ROLLERS.....	31
THE ULTIMATE LAMINATOR TOOL KIT	
LOW COST MEDIA HANDLING GLOVES	
GRAPHIC GLOVES / WRAP GLOVES	
SCRAPERITE / BIG GRIPPER BLADE HOLDER.....	32
4 PC METAL BLADE SCRAPER SET.....	33
THE BIG BLADE JUMBO SIZE PLASTIC RAZOR BLADE	
LIL' CHIZLER	

WRAP TOOLS / ACCESSORIES

WRAP KITS.....	34
POD STEAMER / ACCESSORIES.....	35
WET EDGE SQUEEGEE / WET EDGE MAGNET SQUEEGEE.....	36
SE360 SQUEEGEE / SQUEEGEES.....	37
SQUEEGEES / TEFLON SQUEEGEE TAPE.....	38
SQUEEGEE SHARPENER	
LIL' CHIZLER / THE G-N-G / EZ REACH ULTRA.....	39
SPEED WINGS	
TEFLON HARD CARDS / GATOR BLADE / STROKE BLADE.... 40	
COUNTOUR SQUEEGEE / DOCTOR SQUEEGEE	
QUICK FOOT SQUEEGEE / SLIM FOOT SQUEEGEE	
LITTLE FOOT SQUEEGEE.....	41
ROLLEPRO / MOBILE WRAP LIFT.....	42
HOT SHOT.....	43
MOLDING REMOVAL TOOLS / BODY CLIP SET.....	44
PANEL CLIP PLIERS	
THE HANDLER FILM CUTTER.....	45
MOBILE WRAP TOOL & DETAILERS CART.....	46
RIVET WHEEL / THE TAPE THING / RIVET BRUSH.....	47
WINDOW GAP KNIFE / RETRACTABLE WEEDING TOOL	
BUBBLE POPPER / PLASTIC PRY TOOL	
STAINLESS STEEL PRY TOOL	
XTREME MAGZ / MEGA MAGZ / HEATER HOLDER.....	48
LOW PROFILE MAGNETS	
WRAP KNIFE / TWIN WRAP KNIFE / WRAP GLOVES.....	49
LOW COST MEDIA HANDLING GLOVES / GRAPHIC GLOVES	
EMBLEM REMOVAL TOOL / WRAP HATS.....	50
MAGNETIC GEAR	
INFRARED THERMOMETER / HEAT GUNS.....	51
INSTALLER PEN / SEALITPEN	
WRAP PRO TUCK & GROOVE TOOL KIT.....	52
SOOPER CHAIRS / SHAPES WRAP FILM "SHOW-OFF"	
WRAP CARE PRODUCTS / WRAP VIDEOS.....	53

CUTTING TOOLS & BLADES

ALUMALITE HD LINER / POCKET LINER.....	54
ECONOMY LINER / TWIN WRAP KNIFE / WRAP CUT KNIFE	
SNAPPY SAFE CUTTER / CORO CUTTER.....	55
PEN BLADES / CRAFT & HOBBY TOOL GYRO-CUT	
FOAMBOARD STRAIGHT CUTTER	
OLFA STANDARD DUTY CUTTERS.....	56
OLFA HEAVY DUTY CUTTERS.....	57
OLFA SPECIALTY CUTTERS.....	58
EXCEL GRIP ON KNIFE / RETRACTABLE KNIFE EXECUTIVE.... 59	
RETRACTABLE KNIFE DELUXE	
REVO LOCK-BACK UTILITY KNIFE	
SLIM BODY SNAP BLADE KNIFE	
REPLACEMENT BLADES	
SOOPER GRAPHICS SHOP SET-UP CHECK LIST.....	60

Sooper BRACKETS

Aluminum Powder Coated, will not rust.

SOOPER "U" BRACKETS

Available in 3 Sizes



UBA6075

UBA5050

UBA4025

SOOPER CENTER BRACKETS

Extruded Aluminum.
Available in 3 Sizes

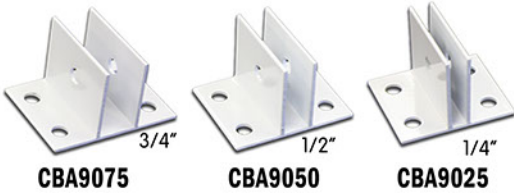

CBA9075

CBA9050

CBA9025

SOOPER SIGN HANGERS

Bolts thru sign face, clean finished look



1/2"

SHA1050



**PICK
N' HOOK**
COROPLAST
Patent No. US 7,627,970

PH100W
(100 Pack - White)

PH100B
(100 Pack - Black)

Simply press the spike-end into the edge of the coro material so that it penetrates across the corrugated flutes, then hang it up.

Both available in White & Black



**TWIST
N' HOOK**
FOAMBOARD
Patent No. US 7,627,970

TH100W
(100 Pack - White)

TH100B
(100 Pack - Black)

Use with foam or gator board. Just twist the hook into the side of your foamboard substrate while pressing it into the foamboard. Once in place, just hang it up.

Both available in White & Black

Sooper Pole Mount

For strapping to large poles

Heavy Duty Aluminum
Silver Powder Coated Finish



Sign Mounting Brackets

- 5/16" Threaded Hole
- Slotted for 3/4" Strap
- Powder Coated Silver Finish



SMBA-1000

Use Stainless Steel
Mounting Straps
to attach
SMBA-1000 bracket
Sold Separately



SEE PAGE 9

SSC188

90° SUPER BRACKET



Universal Mounting
Bracket
(Bright Finish)

BT-1010

TAG-IT BRACKET



- Use to stretch banners between poles, fences, trees, etc.
- Use with Banner Trak to attach to the bottom of the banner



TB1

Use Quick Release
Stainless Steel
Mounting Straps
Sold Separately



SSC188

MORE INFO: 1-800-367-6526 • www.okpaper.com

signAbracket

Corrugated Plastic Mounting Bracket



ROUND POLES



90 DEGREE CORNERS



FLAT WALLS



SAB (Single Pack)

SABB (24 Pack)

MagnAbracket

Corrugated Plastic Mounting Bracket

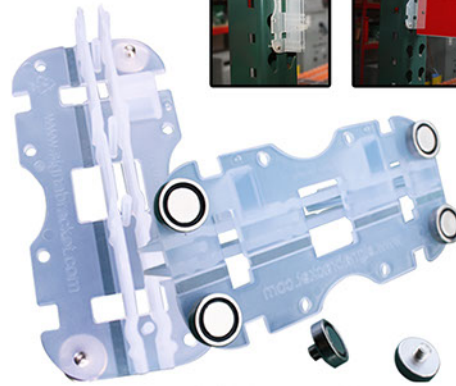

2 SignAbrackets 8 Magnets

SABM2

signclip™

FOR MOUNTING CORRUGATED PLASTICS



View of mounted clip from backside

Kit Includes:

Super clear front bracket, back locking spring clip.
(36" Zip strap not included)

Sold Separately

(20 Pack) SCLIP20

(50 Pack) SCLIP50

(36" Zip Ties) PTRUVBLK

WIND RIDER

FOR USE WITH CORRUGATED PLASTIC SHEETS

- Easy to use
- Affordable
- Reusable
- Attention grabbing
- Easy spins in the wind

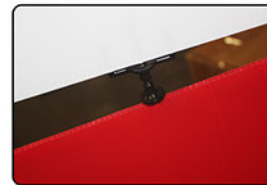

Simply push into both top & bottom sheets

(25 Pack) WR25



STAND-UP SIGN HOLDER

- Black Powder Coated Steel
- Stylish High-Tech Design
- Ideal For Standing Up Media, Single Or Double Sided
- Easy to Use and Re-Use
- POP Display



For use on SF1025B only
SFB2000



SF1025B



SF1050B



SF1050B



SF1000B

SOOPER HINGE

- Make Professional A-Frame Signs
- Sign folds flat when not in use
- 14" long with built in self-loc (no unsightly chains required)
- Fits any thickness from 1/4" and up
- Aluminum Extrusion with black anodized finish
- Makes Any Size A-Frame
- Use 2 hinges to make larger signs



(Sooper Hinge) SH



* Patented
Sooper Feet Optional

SIGN MOUNTING HARDWARE

SOOPER FEET

Sooper Feet



- Keeps your boards off the ground and away from moisture

(Sooper Hinge Feet) SHF

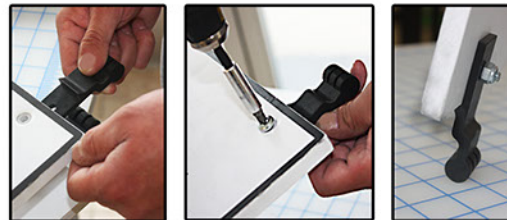

4-PAK SOOPER CEILING HOOKS

- For mounting signs and banners to T-Bar Ceilings.
- Coated with white enamel paint to match most drop ceiling frames.
- Attach to ceiling frames, cabinets or tool boxes.
- 28lbs of pull weight.

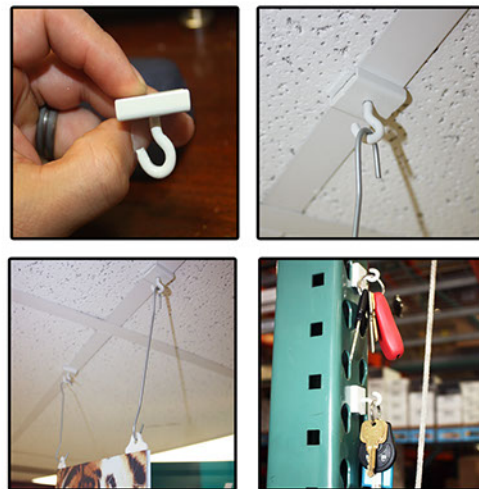
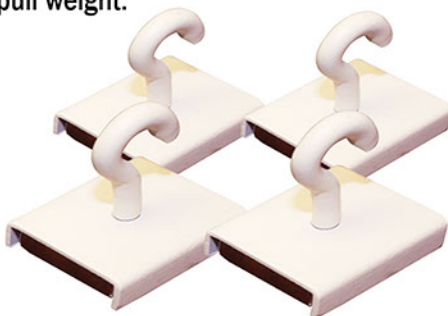

(4-pack) CH4W

MORE INFO: 1-800-367-6526 • www.okpaper.com

Banner Trak



The easy Way To Have Your Banners Hang Straight Every Time



12' x 88" Outdoor Banner. Hung by The Market King Company. "Banner Trak saved us over 10 hours of labor"



- Use your regular grommets with sliders and thumbscrews to attach banner to Banner Trak
- Great for indoor or outdoor use
- Mounts to walls directly with proper hardware
- Optional mounting accessories available - see page 6



Kit includes:

2- 4' Section 1" Wide rail
1- BT-1002 Connector
2- BT-1003 Pair Sliders/ Thumbscrews
1- BT-1005 pair End Caps



BTK1000

TRADE SHOW BANNER BACKDROP KIT

- Easy to Use • Installs in Minutes • Banner Backdrops • Banner Curtain/Dividers • Banner Table Skirts

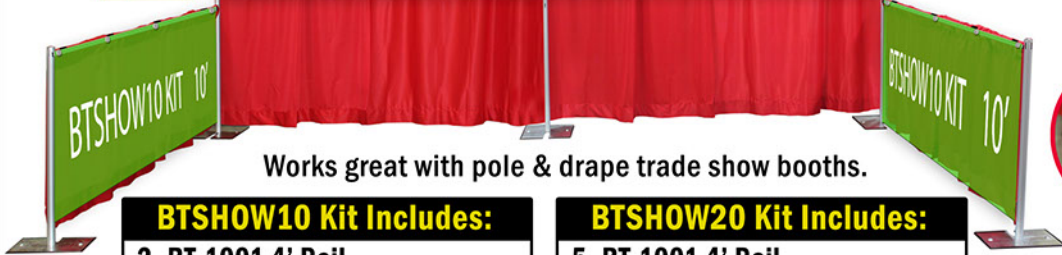

Works great with pole & drape trade show booths.

BTSHOW10 Kit Includes:

2- BT-1001 4' Rail
1- BT-1013 24" Connector
2- BT-1003 Pair Sliders/ Thumbscrews
1- BT-1005 pair End Caps
2- BT-1006 pair Universal Clamps

BTSHOW10

BTSHOW20 Kit Includes:

5- BT-1001 4' Rail
8- SS-PIN Connector Pins
5- BT-1003 Pair Sliders/ Thumbscrews
1- BT-1005 pair End Caps
4- BT-1006 pair Universal Clamps

BTSHOW20



Banner Trak PARTS



Doing large jobs or a unique banner application?

Pick -N- Choose your parts below to build almost any application you can think of.

4' Banner Trak Rail



Use multiple traks to build any size indoor or outdoor banner you need.

BT-1001

Connector

Great for connecting Banner Trak rails together to build your custom size.

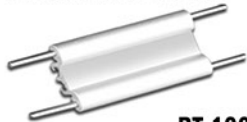

BT-1002

Stainless Steel Pins



Use these pins to directly connect 2 48" or 24" BannerTraks together.

SSPIN

Slider w/thumbscrew



Slide them anywhere on the trak to align with your banners grommet

BT-1003

Slatwall Kit



Use these Slatwall clips with Banner Trak to easily attach to slatwall.

BT-1004

End Caps



Use these end caps on Banner Trak rails for a finished appearance.

BT-1005

Universal Mount Kit



Use these clamps for installing your Banner Trak onto poles.

BT-1006

Suction Cup Kit



Use these suction cups with Banner Trak to mount to any glass or other smooth surface.

BT-1007

T-Bar Ceiling Hooks



The perfect solution to all those drop down ceiling installations.

BT-1008

6" Hang Rods



Use these hang rods whenever you are doing a ceiling or drop down installation.

BT-1009

90° Super Brackets



Use these super strong 90 degree angles with Banner Trak or other sign mounting applications to hang your projects on shelves, posts or walls.

BT-1010

Multi Media Clip



Use these super strong multi-media clips with Banner Trak sliders & thumbscrews or other sign mounting applications to hang your projects.

BT-1011

Xtender



Use this easy connector to extend your Banner Trak to as long as you need.

BT-1012

24" Connector

Use this extender to attach to the 4 foot rails to even out your lengths or add that last 2 feet as needed.

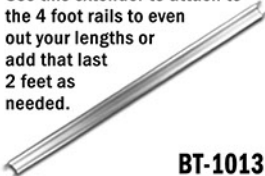

BT-1013

12" Hang Rods

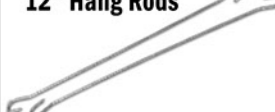

Use these hang rods whenever you are doing a ceiling or drop down installation.

BT-1014

Linklip Chainlink Fence Mount w/Bolt + Linklamp Banner Plate



SLK-3000

SLKLAMP

BT Magz



Use Magnet Mount with BannerTrak for hanging banners on surfaces like Pallet racks, metal shelving or any metal surface.

BTMAG

4-PAK Sooper Ceiling Hooks

Use for mounting Signs or Banners. 28 lbs of pull weight



(4-pack) **CH4W**

SEE PAGE 4

Banner Trak Sample / Sales Kit



A low cost kit for setting up a complete display in your store or a sales kit for your sales people to use with clients

BT-Sample Kit

BANNER TRAK - BANNER MOUNTING HARDWARE

MORE INFO: 1-800-367-6526 • www.okpaper.com

BLACK WALL MOUNT BRACKET KIT

Black glass filled nylon - Vertical wall mount bracket kit to install banners on wall and flat surfaces.

Part#	Description
WBB18	18" Fiber-Glass Pole Wall Mount - Kit
WBB24	24" Fiber-Glass Pole Wall Mount - Kit
WBB30	30" Fiber-Glass Pole Wall Mount - Kit
WBB36	36" Fiber-Glass Pole Wall Mount - Kit

- Indoor use
- Choose Your Pole Size
- 3/4" Solid Poles

*3/4" Poles/Finish banners at 2 1/2" Pole Pocket w/#2 Standard Grommet Recommended



HDWBK

Hardware Kit

Includes:

- 2 Clevis Pins , 2 Clevis Rings
- 2 Plastic End Caps 3/4"
- 2 Cable Ties UV 7 3/4"



POLE BANNER SINGLE KIT - ALUMINUM 1"

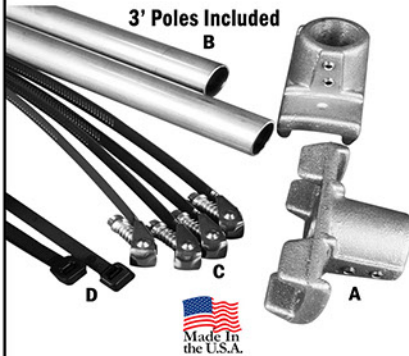

3' Poles Included



SINGLE KIT Includes:

	Qty	Part#	Description
A	2	BMHS1	1" Single Mount Banner Pole Bracket
B	2	BP1M3	1" x 3' Aluminum Pole
C	4	SSC188	Quick Release Stainless Steel Strap 40"
D	2	PTRUVBLK	Cable Ties 36"



BPS036

POLE BANNER DOUBLE KIT - ALUMINUM 1"

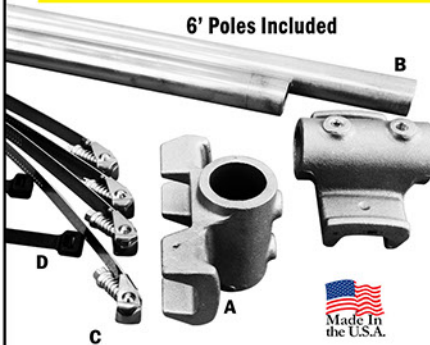

6' Poles Included



DOUBLE KIT Includes:

	Qty	Part#	Description
A	2	CBS1	1" Double Mount Banner Pole Bracket
B	2	BP1M6	1" x 6' Aluminum Pole
C	4	SSC188	Quick Release Stainless Steel Strap 40"
D	2	PTRUVBLK	Cable Ties 36"

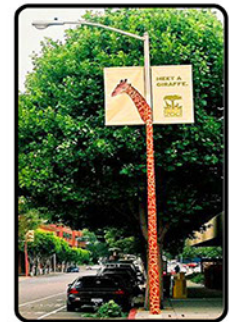

BPD036

1" ALUMINUM POLE BANNER PARTS

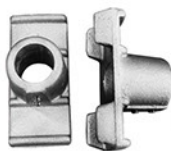

BMHS1
1" Single Mount Banner Pole Brackets

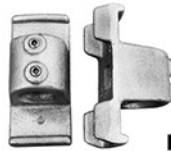

SMS1
1" Mounting Bracket
Horizontal - Vertical

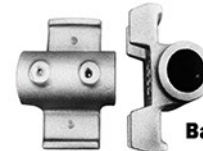

CBS1
1" Double Mount Banner Pole Bracket



MORE INFO: 1-800-367-6526 • www.okpaper.com

HD POLE BANNER SINGLE KIT - ALUMINUM 1.66"

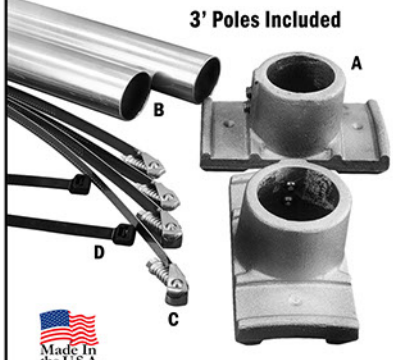

3' Poles Included

- For areas concerned about high winds
- Thicker, stronger Poles

SINGLE KIT Includes:

	Qty	Part#	Description
A	2	BMHS166	1.66" Single Mount Banner Pole Bracket
B	2	BP166M3	1.66" x 3' Aluminum Pole
C	4	SSC188	Quick Release Stainless Steel Strap 40"
D	2	PTRUVBLK	Cable Ties 36"



BPHDS



HD POLE BANNER DOUBLE KIT - ALUMINUM 1.66"



6' Poles Included

DOUBLE KIT Includes:

	Qty	Part#	Description
A	2	CBS166	1.66" Double Mount Banner Pole Bracket
B	2	BP166M6	1.66" x 6' Aluminum Pole
C	4	SSC188	Quick Release Stainless Steel Strap 40"
D	2	PTRUVBLK	Cable Ties 36"



BPHDD



HD 1.66" ALUMINUM POLE BANNER PARTS



BMHS166
1.66" Single Mount Banner Pole Brackets

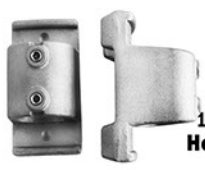

SMS166
1.66" Mounting Bracket Horizontal - Vertical

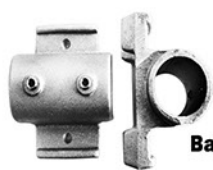

CBS166
1.66" Double Mount Banner Pole Bracket

REPLACEMENT POLES



ALUMINUM POLES

Part#	Size	Description
BP1M3	1" x 3'	Aluminum Pole
BP1M4	1" x 4'	Aluminum Pole
BP1M5	1" x 5'	Aluminum Pole
BP1M6	1" x 6'	Aluminum Pole
BP1M8	1" x 8'	Aluminum Pole
BP1M10	1" x 10'	Aluminum Pole

Part#	Size	Description
BP166M3	1.66" x 3'	Aluminum Pole
BP166M4	1.66" x 4'	Aluminum Pole
BP166M5	1.66" x 5'	Aluminum Pole
BP166M6	1.66" x 6'	Aluminum Pole

MORE INFO: 1-800-367-6526 • www.okpaper.com

POLE BANNER SINGLE KIT - FIBER-GLASS

SINGLE KIT Includes:

- | | |
|------------------|-------------------|
| 2 - Poles | 2 - End caps |
| 2 - Brackets | 2 - Lock rings |
| 2 - Plastic ties | 4 - 40" Stainless |
| 2 - Clevis Pins | steel bands |

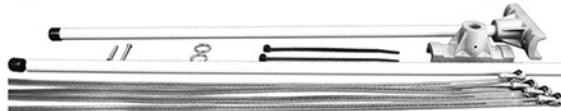

*3/4" Poles - 2 1/2" Pole Pocket w/#2 Grommet Recommended

Part #	Description
AS18	Single set 18" Kit
AS24	Single set 24" Kit
AS30	Single set 30" Kit
AS36	Single set 36" Kit



POLE BANNER DOUBLE KIT - FIBER-GLASS

DOUBLE KIT Includes:

- | | |
|------------------|-------------------|
| 4 - Poles | 4 - End caps |
| 4 - Brackets | 4 - Lock rings |
| 4 - Plastic ties | 4 - 40" Stainless |
| 4 - Clevis Pins | Steel bands |

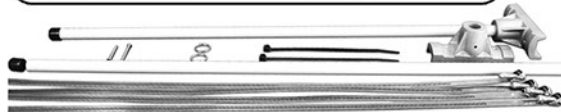

Part #	Description
AD18	Double set 18" Kit
AD24	Double set 24" Kit
AD30	Double set 30" Kit
AD36	Double set 36" Kit



(banner on both sides of pole)

FIBER-GLASS POLE BANNER SPARE PARTS



SSC188



PBAC

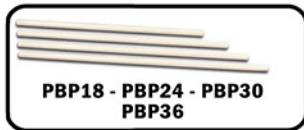

PBP18 - PBP24 - PBP30
PBP36



HDWBK

Part #	Description
PBP18	18" Fiber-Glass Pole
PBP24	24" Fiber-Glass Pole
PBP30	30" Fiber-Glass Pole
PBP36	36" Fiber-Glass Pole
SSC188	Quick Release Stainless Steel Strap
SSC188BLK	Quick Release Stainless Steel Strap Black
PBAC	Aluminum Bracket
HDWBK	Hardware Kit Includes: 2 Clevis Pins, 2 Clevis Rings 2 Plastic End Caps 3/4" 2 Cable Ties UV 7 3/4"

QUICK RELEASE STAINLESS STEEL STRAPS & CABLE TIES UV

SSC188 40" Stainless Steel



SSC188BLK 40" Black



Cable Ties PTRUVBLK 36"

MORE INFO: 1-800-367-6526 • www.okpaper.com

LinKlip™ Chain Link Fence Mounting



LINKLIP

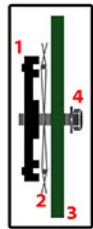

1. LinKlip SLK3000
 2. Chain Link Fence
 3. Substrate (Sign Face)
 4. Bolt
- * 5/16" x 1" bolt
* 18 x 1" thread count



Use LinKlip to Mount Substrates to Chain Link Fence

Mount Sign Faces to Chain link Fence
SLK3000

LINKLAMP

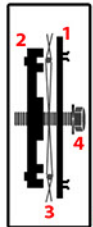

1. LinKlamp SLKLAMP
 2. LinKlip SLK3000
 3. Chain Link Fence
 4. Bolt
- Use with LinKlip

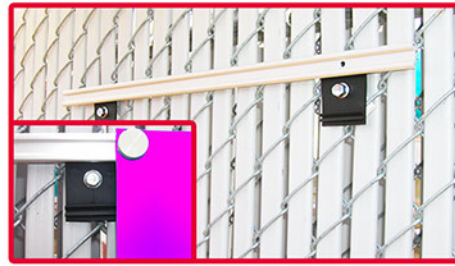

Use LinKlamp with SLK3000 to Mount Banner Trak to Chain Link Fence

Mount Banner Trak to Chain Link Fence using SLK3000 LinKlip and SLKLAMP LinKlamp
SLKLAMP

SIBOLT

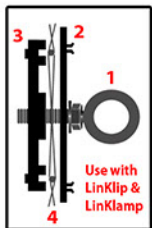

1. Eye Bolt
 2. LinKlamp SLKLAMP
 3. LinKlip SLK3000
 4. Chain Link Fence
- Use with LinKlip & LinKlamp
- * 5/16" x 1" eye bolt
* 18 x 1" thread count



Use LinKlamp with SLK3000 & the SIBOLT to Mount Banners to Chain Link Fence Using Bungies

Mount Banners using Eye Bolts to Chain Link Fence by using SLK3000 LinKlip and SLKLAMP LinKlamp with Eye Bolt to Clamp to fence
SIBOLT

The most simple and affordable solution for all chain link fence
Mounts perfectly on chain link every time!
Hangs solid and flexible substrates easily
The right tool for the job and to keep in your tool box!

MORE INFO: 1-800-367-6526 • www.okpaper.com

BANNER TRAK - BANNER MOUNTING HARDWARE





BannerBond is designed specifically for hemming banners. Our BannerBond tape provides plasticizer resistance and easily tears with your bare hands for quick and easy banner hemming production.

BB1 BB150

Part#	Description
BB1	1" x 72 yds Banner BOND Hemming Tape
BB1C	1" x 72 yds Banner BOND Hemming Tape <small>CASE OF 36 ROLLS</small>
BB150	1 1/2" x 72 yds Banner BOND Hemming Tape
BB150C	1 1/2" x 72 yds Banner BOND Hemming Tape <small>CASE OF 24 ROLLS</small>





The best banner hem tape in the business! Banner Bond-Ultra is a thicker adhesive and offers higher adhesion than Banner Bond. Super tacky and an ultimate bond that keeps any banner media hemmed as intended. Never worry about a banner hem again!

BBU1 BBU150

Part#	Description
BBU1	1" x 72 yds Banner BOND ULTRA Banner
BBU1C	1" x 72 yds Banner BOND ULTRA Banner <small>CASE OF 36 ROLLS</small>
BBU150	1 1/2" x 72 yds Banner BOND ULTRA Banner
BBU150C	1 1/2" x 72 yds Banner BOND ULTRA Banner <small>CASE OF 24 ROLLS</small>

SOOPER STRONG HOOK & LOOP

WHEN YOU NEED SOMETHING STRONGER

This specialty fastener is for applications that require a strong, durable hold and grip. The most aggressive high-cycle closure product in the fastener tapes market.



SSHOOK
SSLLOOP



GENERAL PURPOSE MASKING TAPE

The crepe paper backing tears easily and conforms to curved and irregular surfaces and around corners for sign making, layout and vehicle wrap use. The natural rubber adhesive bonds well to metal, drywall, wood, and painted surfaces and offers clean removal.



1" - 36 yds
2" - 36 yds



GPMT1 GPMT2

For more info go to page 13 **MEGATAPE**

For more info go to page 13 **POLE0520**

BANNER UPS®
POWERTABS
 ADHESIVE GROMMET TABS

- Use Banner Ups PowerTabs® to turn your digital image into a super-strong outdoor banner-instantly!
- No sewing, grommeting or special tools required.



Banner Ups
 Adhesive Grommet Tabs



Corner Tab with Loop BAN 001
 Easy and inexpensive alternative to grommets. Use on banner, foamboard, corrugated plastic & more.



PowerTab BAN 011
 For outdoor or indoor banners



MiniTab BAN 012
 For indoor and light duty outdoor banner



Clear MiniTab BAN 013
 For indoor and light duty outdoor banner



Clear PowerTab BAN 014
 Turn digital images into strong outdoor banners

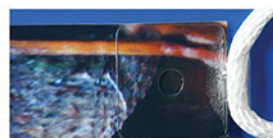

Clear EdgeTab BAN 016
 For outdoor color banner. Use along banner edges for additional support

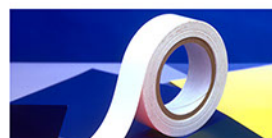

Banner EDGE Tape PTAPE
 Reinforce banner edges without folding or sewing a hem

Banner Ups PowerTabs and PowerTape are easy to use...



Apply to one side



Apply PowerTape® along top and bottom edge on back of banner



Punch hole



Cut off loop if not needed

BANNER UPS®
POWERTAPE
 HEM REINFORCING TAPE



PowerTape
 Part#PTAPE
 Reinforce banner edges without folding or sewing a hem



Apply Banner Ups PowerTabs®



Apply PowerTape® along top and bottom edge on back of banner



Punch hole

PTAPE

Part#	Description	Quantity
BAN001	Regular Banner Ups® - White	100 PCS
BAN001C	Banner Ups® Case Quantity	500 PCS
BAN011	PowerTabs® - White	100 PCS
BAN011C	PowerTabs® Case Quantity	500 PCS
BAN012	Mini PowerTabs® - White	100 PCS
BAN012C	Mini PowerTabs® Case Quantity	1,000 PCS
BAN013	Clear Mini PowerTabs®	100 PCS
BAN013C	Clear Mini PowerTabs® Case Quantity	1,000 PCS
BAN014	Clear PowerTabs®	100 PCS
BAN014C	Clear PowerTabs® Case Quantity	500 PCS
BAN016	Clear EdgeTabs®	100 PCS
BAN016C	Clear EdgeTabs® Case Quantity	500 PCS
PTAPE	PowerTape® 1 1/2" x 36 yds	Each
PTAPEC	PowerTape® 1 1/2" x 36 yds Case Quantity	5

MORE INFO: 1-800-367-6526 • www.okpaper.com

BANNER UPS
MEGATAPE
 HEM REINFORCING TAPE

DOUBLE SIDED VERSION OF THE POWERTAPE

- Withstood winds up to 108 MPH in wind tunnel tests!
- Produces a fold-finished banner edge
- Transparent film ideal for mesh banners
- Dramatically stronger than ordinary double-sided banner hem tape

Made In the U.S.A.

Apply MegaTape® to back side banner edge Remove liner and fold banner edge Apply PowerTabs® or grommet or both

MEGATAPEC (Case of 20 rolls) **MEGATAPE**

BANNER UPS
POLETAPE

This super strong adhesive goes on like tape but sticks like hot melt glue.

Part#	Description
POLE0520	PoleTape 20 mil 1/2" x 200 ft Roll
POLE135	PoleTape 35 mil 1" x 200 ft Roll

BANNER UPS
BRAVOTABS
 FINISH STRONG!

New simple shape works great at corners or along edges

Install BravaTabs® at corners or along edges Use with PowerTape® for ultimate strength Use PowerPunch® to punch hole

100pcs **BAN017**
 500pcs **BAN017C**

BANNER UPS
POWERCLIPS

Reusable • Quick and easy to install
 The harder the pull, the harder they grip!

Large PowerClip Mini PowerClip

Part #	Description
PCMW	PowerClips-Mini White (5 Pack)
PCLW	PowerClips-Large White (5 Pack)

PolyTabs®

Low cost tabs for high volume users. Recommended for top strength with lightweight films. 2000 tabs per dispenser roll. Roll liner is perforated every four tabs. The tabs are economically priced.

White **BAN061**
 Clear **BAN062**

BANNER UPS
POWERPUNCH
 POWERPUNCH - THE PERFECT PUNCH FOR POWERTABS®

POWERPUNCH - PUNCH POWERPUNCH - PUNCH REPLACEMENT PUNCH

PPR516
PPUNCH

MORE INFO: 1-800-367-6526 • www.okpaper.com

MONDO RAXX
Modular Large Format Media Storage

KIT
WALL RACK



Made In the U.S.A.

- Heavy Duty space saving wall mount system
- All Aluminum Construction with bright anodized finish
- For large format Media, Lamination, Canvas, Banner and more
- Can be stacked
- Holds 72" roll material
- Dimension from wall 8 1/4"

MON4000



SLATWALL BRACKET
TO MOUNT ON SLAT WALL

MON4007

MONDO RAXX JUMBO
WALL RACK

Made In the U.S.A.

Media Storage

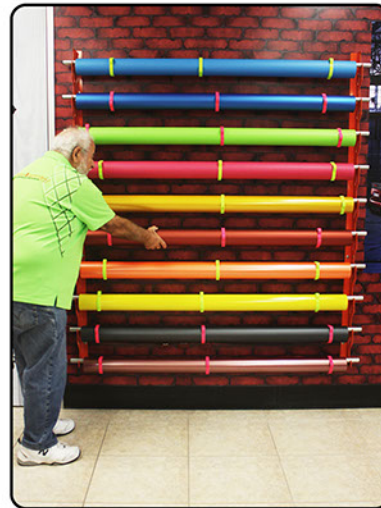

Holds 10 Rolls any size material
(Just mount according to your desired width)

Bright Orange powder coated finish

MJ1000

MONDO RAXX JUMBO
WALL RACK

Made In the U.S.A.

Banner Material Storage



Holds 7 Rolls any size banner material
(Just mount according to your desired width)

Bright Yellow powder coated finish

MJHD2000

MOBILE RACK

Made In the U.S.A.

HOLD 16 ROLLS LARGE FORMAT MEDIA
Organize your Rolls of Media
& Banner Material



- All Steel Construction
- Bright Yellow
- Powder Coated Finish
- Easy Roll HD Locking Wheels
- Instructions Included
- Add your choice of 1" diameter rods (not included)



SPECS:
Length 62" • Width 25" • Height 62" • Off Ground 5"

Part#	Description
MMR1600	Mondo Mobile Rack
RTCT20	Rubber Tips (20 Pk) Fits 1" pipes
RTCT21	Rubber Tips (20 Pk) Fits 1 1/16" pipes

MORE INFO: 1-800-367-6526 • www.okpaper.com

MEDIA RACKS

MOBILE RACK 2" CORE



HD Mobile Floor Rack Holds 12 rolls

- Heavy Square Tube Construction for Excellent Durability
- Powder Coated Silver Vein (Black) Finish
- Heavy Duty Nylon Casters
- Holds 1000 Lbs

Holds 12" to 60" Media Rolls

MR12

MOBILE RACK 3" CORE

MOBILE RACK

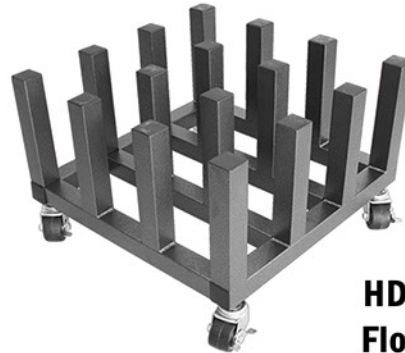

HD Mobile Floor Rack Holds 16 rolls

- Heavy Square Tube Construction for Excellent Durability
- Powder Coated Silver Vein (Black) Finish
- Heavy Duty Nylon Casters
- Holds 1000 Lbs

Holds 12" to 60" Media Rolls

MR16

FLOOR RACK HEAVY DUTY 3" CORE

The Ultimate Organizer for any shop



- Powder coated silver vein (black) finish
- Easy to assemble
- Holds 44 12" to 30" Media rolls

Holds 44 12" to 30" Media rolls

Measures 74¹/₄"H x 32"W x 19"D x 5/6" steel construction

FR44

WALL RACK HEAVY DUTY 3" CORE



Holds 20 12" to 30" Media rolls

- Holds up to 20 rolls of vinyl
- Will hold vinyl rolls up to 30" long
- Powder coated Silver Vein Black Finish
- Easy to Assemble
- Shipping weight: 29 lbs
- Measures 26"H x 32"W x 14"D x 5/6" steel construction

WR20

SOOPER CLIP



Problem



Solution



- Keeps vinyl and print media properly wound
- Simple on/off design with finger hole pull Design
- No more replacing tape or damaging vinyl roll edges
- 2 Sizes for both 10 and 50 yard rolls
- Durable plastic design for longest life and easiest to use
- Doesn't scratch or leave marks on your delicate rolls



(12 Pack - 6 large/6 small) SC12
(50 Pack - 6 large/6 small) SC50

Z-STRAPS



Die-cut hook & loop
Slotted for extra strength
Designed with sign makers in mind



SIZE:
1/2" X 23"



SIZE: 7/16" X 23"

10 Packs

ZS10BLK Black
ZS10RED Red
ZS10BLU Blue
ZS10YLW Yellow

5 Packs

ZS5BLK Black
ZS5RED Red
ZS5BLU Blue
ZS5YLW Yellow



Problem



Solution

CORE ID CARDS



Core ID Cards are available
in 6 colors to categorize
your materials

10 Pack Colors

ID10B Blue
ID10G Green
ID10M Mustard
ID10O Orange
ID10T Turquoise
ID10Y Yellow



12 Pack Asst colors
2 of Each Color
ID12A



Features:

- Prevent getting fingerprints and smudges on the print, substrate, media or film
- Ensure your expensive print medias are protected from oil and sweat transfer from your hands



ONE SIZE FITS MOST!

(1 pair) GGLOVE

LOW COST MEDIA HANDLING GLOVES

When handling print media and substrates,
taking time with the extra special precautions
ensure your precious memories are protected
and preserved.

(1 pair)

MGLOVEM MEDIUM
MGLOVEL LARGE
MGLOVEXL XLARGE



(1 pair)

The WrapGlove is specifically made for the
Wrap/Decal applicators.

WG1S - WG1M - WG1L - WG1XL
SMALL MEDIUM LARGE XLARGE



MORE INFO: 1-800-367-6526 • www.okpaper.com

THE ULTIMATE BANNER STAND



- Portable
- Light Weight
- Sets Up in Seconds
- 4 Sizes Available
- Comes with carry bag
- Tripod style display
- Keeps Message tight for easy viewing

Folds Up

Part#	Banner Description
TP01	22" x 48" Recommended Banner Size: 22" x 46"
TP02	24" x 60" Recommended Banner Size: 24" x 58"
TP03	24" x 70" Recommended Banner Size: 24" x 68"
TP04	40" x 77" Recommended Banner Size: 40" x 75"
TPBH	Brochure Holder

- Measure banners for accuracy before making
- All banners are measured from center of grommets



TPBH

MAXI POD FLOOR BANNER STAND

- Economy Style, LOW COST!
- Holds graphics 24" wide by 48" - 60" height
- Adjustable height gives you more versatility
- One piece construction. Easy up and down
- Banner slides right on with #2 grommets
- Portable, lightweight banner stand
- Comes with carrying case



MP3000

1" QUICK RELEASE CLAMP



- Universal Quick-Release Locking Clamp
- Aluminum Gold Anodized
- Use on any 1" Shaft

QRC256



CLEAR GROMMET PRESS



- Portable Heavy solid steel
- Easy To Use - Includes #3 Die
- Includes 250 Clear Grommets FREE
- Cuts Hole and Sets Grommets in One Easy Motion
- Other Die Sizes Available
- For PVC Banners & Corrugated Plastic

MANO

CLEAR BLACK & WHITE GROMMETS

Part#	Description
GRM1C	CLEAR #1 (8mm) Grommets, 500pcs per pack
GRM1W	WHITE #1 (8mm) Grommets, 500pcs per pack
GRM1B	BLACK #1 (8mm) Grommets, 500pcs per pack
GRM3C	CLEAR #3 (12mm) Grommets, 500pcs per pack
GRM3W	WHITE #3 (12mm) Grommets, 500pcs per pack
GRM3B	BLACK #3 (12mm) Grommets, 500pcs per pack
GRM3LBC	CLEAR #3 (12mm) Long Barrel Grommets, 500pcs per pack
GRM3LBW	WHITE #3 (12mm) Long Barrel Grommets, 500pcs per pack
GRM3LBB	BLACK #3 (12mm) Long Barrel Grommets, 500pcs per pack
GRM4C	CLEAR #4 (16mm) Grommets, 500pcs per pack
GRM4W	WHITE #4 (16mm) Grommets, 500pcs per pack
GRM4B	BLACK #4 (16mm) Grommets, 500pcs per pack

DIES FOR CLEAR BLACK & WHITE GROMMETS

Part#	Dies	Description
PDMA1	#1 Die	for Mano Hand Press (8mm)
PDMA3	#3 Die	for Mano Hand Press (12mm)
PDMA4	#4 Die	for Mano Hand Press (16mm)

DIES FOR METAL GROMMETS

Part#	Dies	Description
MDMA0	#0 Die	for Mano Hand Press Metal Grommet
MDMA1	#1 Die	for Mano Hand Press Metal Grommet
MDMA2	#2 Die	for Mano Hand Press Metal Grommet
MDMA3	#3 Die	for Mano Hand Press Metal Grommet

* To order Metal Grommets see pg. 19 for sizes



THUMB & FOOT PEDAL MODELS

For professional and higher volume shops looking to cut production times and make grommet setting easy.

- Adjustable pneumatic pressure level.
- Completely assembled
- Advanced Safety system
- Interchangeable dies



Thumb Button Press **BRAVOT**
Foot Pedal Press **BRAVOF**
Platform **MPLAT**

CLEAR, BLACK & WHITE GROMMET SIZE GUIDE

* Sizes are approximate



- SUPER STRONG
- NO RUST
- UV RESISTANT
- TURNS INVISIBLE WHEN FINISHED
- RECYCLABLE

Grommet Size	
#1 Clear	5/16"
#1 Black & White	5/16"
#3 Clear	7/16"
#3 Black & White	7/16"
#3 Long Barrel Clear	7/16"
#3 Long/B Black & White	7/16"
#4 Clear	5/8"
#4 Black & White	5/8"

Hole Size	
Inches	MM
5/16"	8
5/16"	8
7/16"	11
7/16"	11
7/16"	11
7/16"	11
5/8"	16
5/8"	16

Flange Diameter	
Inches	MM
5/8"	16
5/8"	16
1 1/16"	27
1 1/16"	27
1 1/16"	27
1 1/16"	27
1 1/8"	28.5
1 1/8"	28.5

Length Under Flange	
Inches	MM
5/16"	8
5/16"	8
5/16"	8
5/16"	8
3/8"	10
7/16"	10
1/2"	13
1/2"	13

For the ImageOne Impact®, Mano Press & Clear Dies for Hiker, Fastnap, Stimpson, Sooper Ace & More.

MORE INFO: 1-800-367-6526 • www.okpaper.com



METAL GROMMETING TOOLS & GROMMETS

- Portable Heavy Duty Cast Iron
- Includes #2 Die
- Easy To Use
- Cuts Hole and Sets Grommets in One Easy Motion
- Other Die Sizes Available



GRMBUFACE

ACE IN THE HOLE METAL GROMMETS			SOOPER ACE DIES FOR METAL GROMMETS		
Part#	Dies/Size	Description	Part#	Dies	Description
GRM0SPB	#0 1/4"	Self Piercing BRASS	GRMBD0	#0 Die	for Ace Grommet Machine
GRM1SPB	#1 5/16"	Self Piercing BRASS	GRMBD1	#1 Die	for Ace Grommet Machine
GRM2SPB	#2 3/8"	Self Piercing BRASS	GRMBD2	#2 Die	for Ace Grommet Machine
GRM2SPN	#2 3/8"	Self Piercing NICKEL	GRMBD3	#3 Die	for Ace Grommet Machine
GRM2SPBLK	#2 3/8"	Self Piercing BLACK	* Work on Sooper Ace Grommet Press & Econo Air Grommet Press		
GRM2SPLBB	#2 3/8"	Self Piercing Long Barrel BRASS			
GRM3SPB	#3 7/16"	Self Piercing BRASS			

DIE FOR PLASTIC GROMMETS SOOPER ACE PRESS			#2 HIKER DIE FOR METAL GROMMETS	#2 STIMPSON DIE FOR METAL GROMMETS
Part#	Die	Description		
PDSA3	#3	Die #3 for Plastic Grommets	 #2 Die GRMHD2	 #2 Die GRMSD2
PDSA3C	#3	Combo - Die #3 + 500 Grommets		

* To order Plastic Grommets see pg. 18



PNEUMATIC GROMMET PRESS

- Economical and easy to use!
- Hands-free foot pedal activation
- Adjustable pneumatic pressure level
- Completely assembled as shown
- Comes with #2 metal die.
- Optional Dies sizes available for additional cost. (check Sooper Ace Grommet Press Dies)



ECONO

SOOPER ACE METAL GROMMET SIZE GUIDE

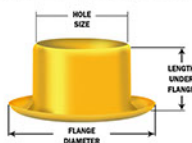

* Sizes are approximate

Grommet Size	Hole Size		Flange Diameter		Length Under Flange	
	Inches	MM	Inches	MM	Inches	MM
#0	1/4"	6	9/16	14	3/16	4.5
#1	5/16"	8	5/8	16	1/4	6
#2	3/8"	9.5	11/16	17.5	1/4	6
#2 Long Barrel	3/8"	9.5	11/16	17.5	5/16	8
#3	7/16"	11	1	25	1/4	6

For the ImageOne Impact®, Sooper Ace™, Stimpson®, Micron® and Fasnap® grommet presses

CLEAR GROMMET COMBO KITS

Convert your grommet machine to Clear Grommets

SOOPER ACE COMBO KIT



Sooper Ace Combo Pack
Includes Replacement Die
Plus 500 #3 Clear Grommets
3 lbs

PDSA3C

Die Only **PDSA3**

STIMPSON COMBO KIT



STIMPSON Combo Pack
Includes Replacement Die
Plus 500 #3 Clear Grommet
3 lbs

PDST3C

Die Only **PDST3**

HIKER COMBO KIT



HIKER Combo Pack
Includes Replacement Die
Plus 500 #3 Clear Grommets
3 lbs

PDHI3C

Die Only **PDHI3**

FASNAP COMBO KIT

Cast Iron



FASNAP-Cast Iron Combo Pack
Includes Replacement Die
Plus 500 #3 Clear Grommets,
3 lbs

PDFNC13C

Die Only **PDFNC13**

FASNAP COMBO KIT

Aluminum



FASNAP Aluminum Combo Pack
Includes Replacement Die
Plus 500 #3 Clear Grommets
3 lbs

PDFNAL3C

Die Only **PDFNAL3**

MANO COMBO KIT METAL GROMMETS

Convert Clear Grommet Press
to Metal Grommet Press

Kit includes:

- Die #2
- 500 #2 Grommets
(GRM2SPB)



MDMP2C



**The Fastest
Easiest and
Most Affordable
way to Round
Corners**

- Includes 1/4" and 3/8" interchangeable radius blades
- Cuts Up to .080 Aluminum
- Up to 1" Card Stock, Plastics, Magnetic sheets and More...
- Heavy Dury Cast Iron Base
- Drop down foot holds material in place while cutting

SR3000

REPLACEMENT DIE SETS AVAILABLE

1/8" - 3/16" - 1/4" - 3/8" & 1/2"

(Sets Includes: Radius Base + Cutter Blade)

Radius base



Cutter Blade



Part#	Description
SRDC18	1/8" Cutter Blade + Radius Base
SRDC36	3/16" Cutter Blade + Radius Base
SRDC14	1/4" Cutter Blade + Radius Base
SRDC38	3/8" Cutter Blade + Radius Base
SRDC50	1/2" Cutter Blade + Radius Base

XPERT COMBO KIT

Kit Includes: Corner Rounder + Hole Punch + Tool Base for your Arbor Press



The best value combination kit Includes:

- 4 Radius sizes in one tool: 1/4" - 1/2" - 3/4" & 1"
- 1/4" Hole Punch - For in-line & corner punching
- Tool Base - For easy tool swapping
- Corner Rounder and Hole Punch drop easily into the base
- Can be swapped on the fly
- Operates using any standard basic Arbor Press (Arbor press NOT included)

Part#	Description
XPCOMBO	XPRT COMBO KIT

XPRT CORNER ROUNDER

- The ultimate tool for rounding corners
- Will cut substrates up to .080 aluminum
- No set up needed - No measuring for a different radius
- 4 Radius sizes in one tool: 1/4" - 1/2" - 3/4" & 1"
- Operates using any basic manual Arbor Press
- Must be used with Xpert Tool Base Part# XPTB (Arbor press NOT included)

XPCR

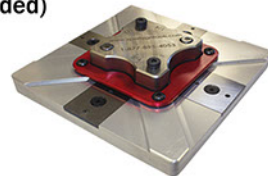

XPRT HOLE PUNCH

CHOOSE
1/4" OR 3/8"
HOLE SIZE

- The ultimate tool for punching holes
- Solid aluminum base plate
- Will punch holes up to .080 aluminum
- Consistent, accurate holes everytime
- Adjustable guide blocks allow you to punch holes 1/4" - 1/2" - 3/4" - 1" away from corners
- Operates using any basic manual Arbor Press
- Must be used with Xpert Tool Base Part# XPTB (Arbor press NOT included)

XPRT Tool Base



XPTB



XHP14

XHP38

Part#	Description
XPCR	XPRT Corner Rounder
XHP14	XPRT 1/4" Hole punch
XHP38	XPRT 3/8" Hole punch
XPTB	XPRT Tool Base

For Xpert Tools - We recommend The 3552 1-TON Arbor Press from Harbor Freight

Soooper Edge

The ULTIMATE Safety Ruler

The Sooper Edge is the premier safety ruler in the sign and graphics industry



More Features & Benefits than any other Safety Ruler!

- Made of heavy duty aluminum construction
- Polished and anodized
- Non-slip grip on the bottom
- Excellent curved finger guard
- Laser etched graphics and measurements
- Inserted stainless steel edge to eliminate cutting into the ruler
- Channel on back to hold cutting head so all sizes make perfectly straight cuts the entire length

Standard Sizes

Metric Sizes

Part#	Description
ESL28	28" Safety Ruler
ESL40	40" Safety Ruler
ESL52	52" Safety Ruler
ESL64	64" Safety Ruler
ESL76	76" Safety Ruler
ESL96	96" Safety Ruler
TS15BK	Black T-Square
WC6001	Cutting Head

Part#	Description
ESL28M	71.1 cm Safety Ruler
ESL40M	101.6 cm Safety Ruler
ESL52M	132.1 cm Safety Ruler
ESL64M	162.6 cm Safety Ruler
ESL76M	193 cm Safety Ruler
ESL96M	243.8 cm Safety Ruler
TS15BK	Black T-Square
TS15BK	Black T-Square Metric
WC6001	Cutting Head

Optional

ADJUSTABLE
T-SQUARE
THE BEST JUST GOT BETTER



Works on
Soooper Edge Ruler
and
The Big Blue Ruler

TS15BK

Optional Cutting Head

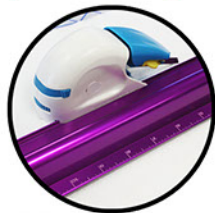

Works on
Soooper Edge Ruler
and
The Big Blue Ruler

WC6001

The Big Blue

safety ruler

Big Blue Safety Ruler is the one choice for the finishing room



More Features & Benefits than any other Safety Ruler!

- Made of heavy duty aluminum construction
- Polished and anodized
- Non-slip grip on the bottom
- Excellent curved finger guard
- Laser etched graphics and measurements
- Channel on back to hold cutting head so all sizes make perfectly straight cuts the entire length

Standard Sizes

Metric Sizes

Part#	Description
ECSL28	28" Safety Ruler
ECSL40	40" Safety Ruler
ECSL52	52" Safety Ruler
ECSL64	64" Safety Ruler
ECSL76	76" Safety Ruler
ECSL96	96" Safety Ruler
TS15BK	Black T-Square
WC6001	Cutting Head

Part#	Description
ECSL28M	71.1 cm Safety Ruler
ECSL40M	101.6 cm Safety Ruler
ECSL52M	132.1 cm Safety Ruler
ECSL64M	162.6 cm Safety Ruler
ECSL76M	193 cm Safety Ruler
ECSL96M	243.8 cm Safety Ruler
TS15BK	Black T-Square
TS15BK	Black T-Square Metric
WC6001	Cutting Head

2" Non-Slip Grip Tape 50ft roll



DRTAPE2

Soooper Six Ruler



SSX

MORE INFO: 1-800-367-6526 • www.okpaper.com

X-TREME HEAVY DUTY ALUMINUM STRAIGHT EDGE "FOUR PACK"

* A size for every Job!

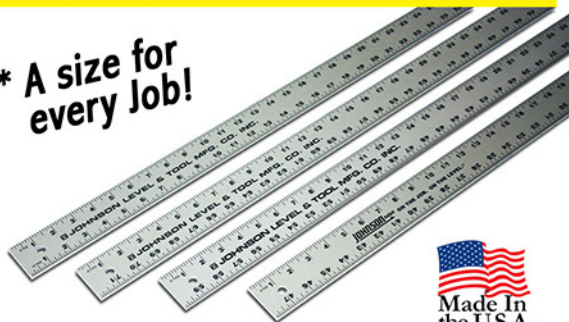

Set includes: 4', 5', 6' and 8', lengths

XJ4PAK

X-TREME STAINLESS STEEL RULERS

- Come in three styles and three lengths
- Available three lengths 12" - 18" - 24"
- Come in three styles
 - Plain back standard,
 - Cork back for non-slip stability,
 - Magnetic back for vehicles.

3 sizes Each in Plain, Cork or Magnetic back

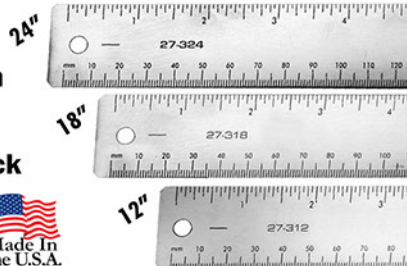

Part#	Description
F27-312PL	12" Plain Scale
F27-318PL	18" Plain Scale
F27-324PL	24" Plain Scale
Part#	Description
F27-312	12" Cork Back Scale
F27-318	18" Cork Back Scale
F27-324	24" Cork Back Scale
Part#	Description
F27-312M	12" Magnetic Back Scale
F27-318M	18" Magnetic Back Scale
F27-324M	24" Magnetic Back Scale

DESIGNER'S LAYOUT RULERS



OLFA ruler makes any project easier, whether you're working with fabrics, paper or other materials.

DETAILS:

- Frosted acrylic surface allows black imprinted numbers to be read effortlessly
- Frosted surface is non-slip for extra stability and safety when cutting
- Designed for accuracy and precision with grid lines marked in 1/8", 1/4", 1/2" and 1" increments



QR6X24



QR6X12



QR6S

COMPLETE WEEDING KIT

- Strong Stainless Steel tips
- Chrome Handles
- Five different angles for picking and weeding anything
- Cast, Calendered, Heat Transfer & more...



CWK

WEEDING PEN

Our Weeding pen is a larger sized "ball point pen" style tool with a larger round pin point. This tool retracts and protracts just like a "ball point pen" as well.



Weeding Pen **WPEN**
Weeding Pen Refill **WPR**

RETRACTABLE WEEDING TOOL

Aluminum retractable Bubble Popper/Weeding Pen with pocket clip used for making holes, also as a marking point in leather, paper, wood, plastic, etc.
.31 x 5in - .8 x 12.7cm
Made In USA

.030" Tip



Excel
Our Edge Makes the Difference
WEED30

RETRACTABLE WEEDING TOOL

Aluminum retractable weeding pen with pocket clip used for making holes, also as a marking point in leather, paper, wood, plastic, etc.
.31 x 5in - .8 x 12.7cm
Made In USA

.060" Tip



Excel
Our Edge Makes the Difference
WEED60

RETRACTABLE WEEDING TOOL

Aluminum retractable weeding pen with pocket clip used for making holes, also as a marking point in leather, paper, wood, plastic, etc.
.31 x 5in - .8 x 12.7cm

.090" Tip



Excel
Our Edge Makes the Difference
WEED90

PRO-Roll Tape Applicator

The PRO-Roll is available in 2 sizes. Each size works with widths up to that size tool.

- No more wrinkles when applying.
- Change to a new roll in seconds.
- Works with any brand, paper weight and tack level of application tape.

Adding/Changing a tape roll is as easy as 1-2-3



Recommended by: **TransferRite**



Look at these Great Quality Features:



PRO-Roll 12" - tapes from 3" to 12" **TA12**
PRO-Roll 24" - tapes from 3" to 24" **TA24**

MORE INFO: 1-800-367-6526 • www.okpaper.com

TABLE FRAMES

ALUMINUM FRAMES, MOBILE WITH HD LOCKING WHEELS

- 4' x 8' base frame with HD Locking Wheels
- Will hold up to 6' x 12' table top
- Add your own desired top from Cabinet Shop or Lumber Yard
- Super Strong precision fit Aluminum Extrusions
- Perfect finished height of 34" inches
- EZ to Assemble - Tools and Instructions Included
- Permanent shop table for years and years of use
- Ships Knocked Down (UPS - Fedex)



TBLF
(Shown with 5'x10'
Table Top NOT Included)



TBLFEXT 4' x 4' Extension



TBLAB48
Adjustable
Shelf Bracket 48"



TBLHNDLRMT
Table Top Handler Mount



Part#	Description
TBLF	4' X 8' Aluminum Table Frame
TBLFEXT	4' X 4' Aluminum Table Extension
TBLHNDLRMT	Table Top Handler Mount
TBLAB48	Adjustable Shelf Bracket 48"

See page 45 for
THE HANDLER info.

MOBILE MULTI USE TABLE FRAME WITH HD LOCKING WHEELS

- 2' x 4' base frame with HD Locking Wheels
- Will hold up to 4' x 6' table top
- Super Strong precision fit Aluminum Extrusions
- Perfect finished height of 34" inches
- Ideal for Small Worktable - Tool Carrier - Flat Beds Plotters - Laminator etc
- EZ to Assemble - Tools and Instructions Included
- Permanent shop table for years and years of use
- Ships Knocked Down (UPS - Fedex)

Adjustable Shelf Brackets 24" not included.



TBLAB24

TBL2448

Adjustable Shelf Bracket 24" TBLAB24



SIMPLY THE BEST COUNTER TOP CUTTING MAT

- Protect Your table Top
- Cutting Blades Last Longer
- Made From Virgin High Impact Polymer Blend
- Sooper Tough

GRID KITS

Available for
Cutting Mats up to
6' x 12'



OLFA® Knives Recommended

• SVR-1 • SVR-2 • SAC-1 • XA-1 • PA-2 • AK-4 • 180 • DA-1

Part#	Size	Inches / Description
CM1824P	1.5' x 2'	18" x 24" Printed
CM2436P	2' x 3'	24" x 36" Printed
CM2448	2' x 4'	24" x 48" Unprinted
CM2448G	2' x 4'	24" x 48" 1 Grid
CM48	4' x 8'	48" x 96" Unprinted
CM48G	4' x 8'	48" x 96" 1 Grid
CM410	4' x 10'	48" x 120" Unprinted
CM410G	4' x 10'	48" x 120" 2 Grid
CM412	4' x 12'	48" x 144" Unprinted
CM412G	4' x 12'	48" x 144" 2 Grid
CM58	5' x 8'	60" x 96" Unprinted
CM58G	5' x 8'	60" x 96" 2 Grid
CM510	5' x 10'	60" x 120" Unprinted
CM510G	5' x 10'	60" x 120" 3 Grid
CM512	5' x 12'	60" x 144" Unprinted
CM512G	5' x 12'	60" x 144" 3 Grid
CM610	6' x 10'	72" x 120" Unprinted
CM610G	6' x 10'	72" x 120" 3 Grid
CM612	6' x 12'	72" x 144" Unprinted
CM612G	6' x 12'	72" x 144" 3 Grid

MORE INFO: 1-800-367-6526 • www.okpaper.com

SOFT GRIP 8" SCISSORS

Stainless steel body with injection molded handles and tapered inlay. For cutting and trimming PSV Films, tapes, paper, cloth, plastics and other mediums. 8.0in - 20.3cm



YARD STICK COMPASS CUTTER

Yardstick Compass - Swivel, Pin Post, Lead
For slicing or cutting large areas and circles; attaches to any standard ruler or yardstick (ruler not included). Made In USA



COMCUT



COMCUTB

CRAFT AND HOBBY TOOL GYRO-CUT

The amazing GYRO-CUT® craft and hobby tool is designed to easily cut thin sheet materials such as paper, thin card up to 240gsm, vinyls, thin mylar sheet, masking material, decoupatch, etc. This hand-held tool has a 360 degree rotating blade which enables you to cut very complex shapes easily and quickly.



2-pak Replacement Blades



GCBLADE2

Hand held Knife



GCKNIFE

THE YELLOW/BLACK TOOL POUCH

Features a tiered pocket design that allows for easy access and organization of tools and accessories. Our "Sooper Tool Pouch" is made with a lightweight material with proven durability.



Tools not included

TPOUCH1

THE MAGNET TOOL POUCH

Every aspect of our small gray and black Pro Wrap Tool Pouch was built around the features vehicle graphics installers need to work efficiently. Offering you 1 large main pouch with 2 small pouches inside and 2 small pouches outside and 5 knife pockets give you access to everything you need at your fingertips. Even has metal inserts to hold an entire set of "Xtreme Magz"



TPOUCH4

ALUMALITE SQUEEGEES



- Light weight aluminum construction
- Use for small and large applications
- Great for large format installs on windows - vehicles and any large surface window - walls - floors etc.
- Available in 6 sizes up to 50" wide
- Sooper - Glide felt edges for smooth application with no harm to sign or substrate

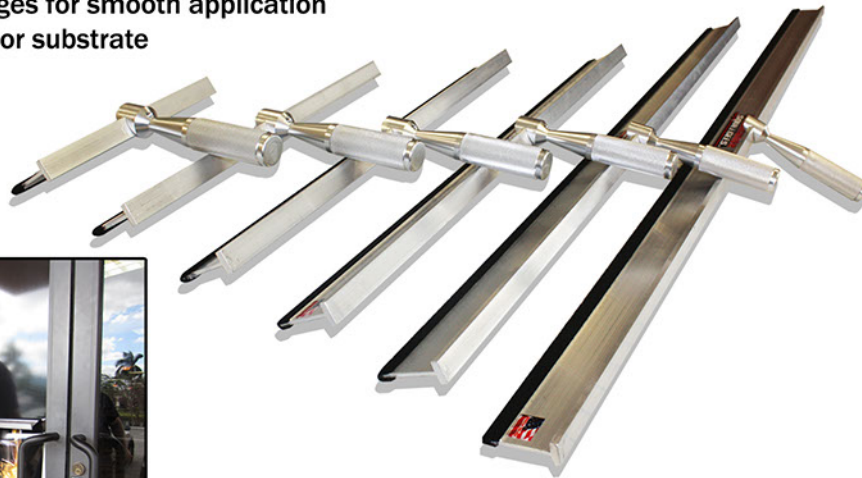

*** SOLD INDIVIDUALLY OR VALUE PACKS**

Part#	Description
SQAL08	8 inch Aluminum squeegee
SQAL14	14 inch Aluminum squeegee
SQAL20	20 inch Aluminum squeegee
SQAL26	26 inch Aluminum squeegee
SQAL38	38 inch Aluminum squeegee
SQAL50	50 inch Aluminum squeegee
SQAL5PAK	5-PAK Includes: 8", 14", 20", 26", 38" Alum. Squeegees
SQAL6PAK	6-PAK Includes: 8", 14", 20", 26", 38", 50" Alum. Squeegees

ALUMALITE HD LINER CUTTER

- Precision Hand-Held Cutter
- Uses standard single edge razor blade
- Simple Blade Depth adjustment
- Controls the depth of cut
- Blade can be mounted on either side for Right hand or Left hand use



ALHDLCT
650506
 (Blades 100-Pak)

MORE INFO: 1-800-367-6526 • www.okpaper.com

ALUMALITE THREADED HANDLE



- Optional Threaded Handle for use with standard paint roller extension.
- Great for use with installation of floor and wall graphics



Shown with extender pole
(handle not included)



SQALXTH

THE G-N-G SQUEEGEE

- Sturdy 2-Piece Construction
- Interchangeable blades easily, snap in and out
- Firm ergonomic hand grip
- Yellow Grip-N-Glide for window film installations
- Orange Grip-N-Glide for paint protection film vinyl graphics and Wrap Films.

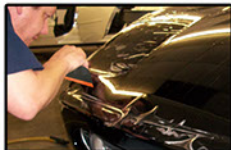

For Window Films



SQGNGY

For PPF & Wraps



SQGNOR

GNG Replacement Blade
Yellow



GNGBLADEY

GNG Replacement Blade
Red



GNGBLADER

CORO CUTTER COROCUT



SNAPPY SCUT SAFE CUTTER



ECONOMY LINER LCTECO



*For more info go to page 54

SPINNING ORGANIZERS

Organize Your Work Area

Spinning Organizer, comes with a balsa wood topper to hold your knives.

- 72 Compartments
- Rotates on base
- 7 "Mini Trays" at your fingertips
- Five Storage Levels
- For Home, Office, Shop or Studio

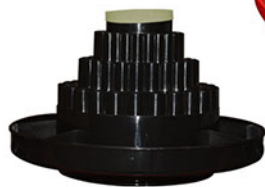

Part#

Description

ST98932	Spinning Shop Organizer - Black
ST98933	Spinning Shop Organizer - Red

3M Dispenser

Tape Dispenser Organizer

Get Organized!

This 6" Wide Dispenser Holds Any Combination Of Tape Up to 6" Wide



XP56

ROLLER SQUEEGEE BRAYERS

Our 3" narrow Roller Squeegee/Brayer is the perfect size for applying banner hem tapes and double-sided tapes onto your substrates and surfaces.

Our 6" medium-wide Roller Squeegee/Brayer is the perfect size for use with small graphic applications and for use on vehicle wraps where you can't risk dragging a plastic squeegee across the graphic or media.

Our 12" wide Roller Squeegee/Brayer can tackle your large applications indoors or out. Wall Graphics, trailer graphics and big rig jobs are much faster and easier when you add our 12" wide roller squeegee/brayer.



Part#

Description

RLSQ3	3" Narrow Roller Squeegee/Brayer
RLSQ6	6" Medium-wide Roller Squeegee/Brayer
RLSQ12	12" Wide Roller Squeegee/Brayer



MORE INFO: 1-800-367-6526 • www.okpaper.com

SOOPER TACK ROLLERS

Removes Every Spec of Unwanted Dust and other Particles from Surfaces before Printing, Laminating or Applying Graphics

Each kit includes:

- 1 Tack Roller • 1 pad of 50 cleaning sheets



Available in 3 tack levels

Part#	Description
DR12ALT	12" Low Tack Dust Removal Kit
DR12AMT	12" Med Tack Dust Removal Kit
DR12AHT	12" High Tack Dust Removal Kit
CP50	Cleaning Pad of 50 sheets, 9" x 13"
CP50B	5 Pads Per Box

THE ULTIMATE LAMINATOR TOOL KIT

Each laminator must have one of these kits. Finally a complete kit for eliminating static electricity and build up.

Contents:

- 12 Page booklet with essential laminating advice.
- 1 Pair of Graphic Gloves
- 1 Set of Static Elastic Wire with magnet mounts
- 1 Economy Liner Cutter



LAMKIT

LOW COST MEDIA HANDLING GLOVES

When handling print media and substrates, taking time with the extra special precautions ensure your precious memories are protected and preserved.



- MGLOVEM MEDIUM
 - MGLOVEL LARGE
 - MGLOVEXL XLARGE
- (1 pair)



The WrapGlove is specifically made for the Wrap/Decal applicators.

- WG1S Small
- WG1M Medium
- WG1L Large
- WG1XL XLarge



(1 pair)



Used daily by professionals in the graphics industry, the GraphicsGlove™ will ensure your expensive print medias are protected from oil and sweat transfer from your hands, offer excellent glide when used during hand-cutting in the shop or in the field. And, this is why treating print media, substrates and even prints and photos with care upfront should always be a priority in your shop.

Features:

- Prevent getting fingerprints and smudges on the print, substrate, media or film
- Ensure your expensive print medias are protected from oil and sweat transfer from your hands



ONE SIZE FITS MOST!

(1 pair) GGLOVE

ScrapeRite

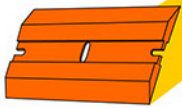

PLASTIC RAZOR BLADES

NO MORE SCRATCHES!

faster, better, safer scraping and cleaning



GENERAL USE
Delicate Surfaces

25 Pack Orange
with one Holder
General Purpose

SR25GPO



HARD & FLEXIBLE
Convex Surfaces

25 Pack Blue
with one Holder
Polycarbonate

SR25PCB



GENERAL USE
Delicate Surfaces

100 Pack Orange
Blades Only
General Purpose

SR100GPO



HARD & FLEXIBLE
Convex Surfaces

100 Pack Blue
Blades Only
Polycarbonate

SR100PCB



CDBGPO 50 per Box - Orange
CDBPCB 50 per Box - Blue



BIG GRIPPER BLADE HOLDER

Big Gripper holder designed to hold ScrapeRite plastic razor blades, longer handle provides more leverage and added reach and is more comfortable to use for large jobs or repeated use.

Polycarbonate blade included - flexible and durable with mild chemical resistance for use on uneven surfaces like painted steel, counter tops and hard wood.



BigGripper Blade Holder
+ 2 polycarbonate
blue blades
BG400

MORE INFO: 1-800-367-6526 • www.okpaper.com

4 PC METAL BLADE SCRAPER SET

Set contains:

All Purpose switchblade style Scraper • Extended Scraper • 2 Hand Scrapers

Excellent for scraping glass, walls, metals, floors and many other durable surfaces.

Weight: 1.00 lbs.



SCRAPE4

THE BIG BLADE JUMBO SIZE PLASTIC RAZOR BLADE

- Safe, Strong, plastic DOUBLE EDGED BLADE
- Strategically beveled scraping and lifting edges
- Functionally designed with a solid back for both strength and flexibility.
- The two chemically resistant models are available in either flexible or rigid.
- The new materials are specifically formulated to withstand the effects of the removal fluids used in the marketplace • Size: 3" x 4"

Chemical Resistant
Flexible Blue

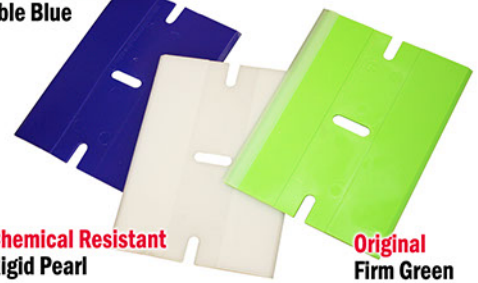

Chemical Resistant
Rigid Pearl

Original
Firm Green



Part#	Description
BBFIRM	Big Blade Removal Tool- Firm - Green
BBCRF	Chemically Resistant Big Blade-Flexible - Blue
BBCRR	Chemically Resistant Big Blade-Rigid - Pearl

LIL' CHIZLER

The Lil' Chizler's unique design enables it to remove stickers and vinyl letters easily.

Make sure area is free of dust & debris and it will not scratch... even plexi-glass and clear coat paints.



LILCHZL

DIGITAL VARIABLE TEMPERATURE HEAT GUN KIT

- "Soft Touch" Control for more exact temperature setting
- High and Low settings each have 6 temp. settings 12 heat settings total



* For more info see page 51

HGDVT

WRAP KIT PRO

Used by professional wrap shops all over the world!
Our selection of products are designed to last longer
and are the right set of tools for the installer.

KIT INCLUDES:

- Wet Edge Squeegee
- Wrap Glove (1 pair size large)
- 4" Standard Orange Squeegee
- 4" Gold Nylon Blend Squeegee
- Wrap Cut Liner Cutting Knife
- Retractable Bubble Popper - .030
- Emblem Removal Tool with 100 cutting cords
- Wrap Pro Tuck & Groove (7) Piece Tool Kit
- Ultra Slim Cutter
- The Gray/Black Tool Pouch
- Xtreme Magz 6-pak w/ring handles
- 6" White Plastic Squeegee
- Blade Disposal Can
- Installers Rivet Wheel
- Rivet Brush
- Infrared Thermometer with Laser
- Dual Temperature Heat Gun Kit
- Window Perf Gap Knife with Twin Parallel Blades
- Auto Lock Stainless Steel Professional Knife
- HD Box Chair
- General Purpose / Orange - 25 per pack
- Rollepro Applicators
- Molding Removal Tools - 11 piece set



**Every installer
needs this kit!**

WKIT3

WRAP KIT Student

KIT INCLUDES:

- Wet Edge Squeegee
- Wrap Glove (1 pair size large)
- 4" Standard Orange Squeegee
- 4" Gold Nylon Blend Squeegee
- Wrap Cut Liner Cutting Knife
- Retractable Bubble Popper - .030
- Emblem Removal Tool with 100 cutting cords
- Wrap Pro Tuck & Groove (7) Piece Tool Kit
- Ultra Slim Cutter
- The Gray/Black Tool Pouch
- Xtreme Magz 6-pak w/ring handles
- 6" White Plastic Squeegee
- Blade Disposal Can
- Installers Rivet Wheel
- Rivet Brush
- Infrared Thermometer with Laser
- Dual Temperature Heat Gun Kit
- Window Perf Gap Knife with Twin Parallel Blades



WKIT2

WRAP KIT Beginner

KIT INCLUDES:

- Wet Edge Squeegee
- Wrap Glove (1 pair size large)
- 4" Standard Orange Squeegee
- 4" Gold Nylon Blend Squeegee
- Wrap Cut Liner Cutting Knife
- Retractable Bubble Popper - .030
- Emblem Removal Tool with 100 cutting cords
- Wrap Pro Tuck & Groove (7) Piece Tool Kit
- Ultra Slim Cutter
- The Gray/Black Tool Pouch
- Xtreme Magz 6-pak w/ring handles



WKIT1

MORE INFO: 1-800-367-6526 • www.okpaper.com



POD

PRESSURE ON DEMAND

SYSTEM

“A MUST HAVE” FOR EVERY SHOP

- Vehicle Wraps
- Window Tint
- PPF - Paint Protection Film
- Auto Detailing
- Eliminates Broken glue, Stretch marks, Silvering, Whitening of Chrome.
- Ability to correct mistakes without wasting additional film.
- Pre and Post heating for vehicle wraps.
- Pre and Post Cleaning of Vehicles.
- Removal and debadging.
- Delivers steam at a reduced temperature, does not harm the film, the vehicle or the Installer.
- Steam almost everything on your vehicle, inside and out.
- Now holds 1.5 liter, enough to clean and steam the average vehicle.



Euro Model Available.

POD
POD220V

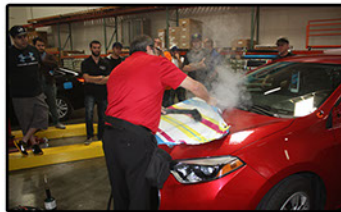
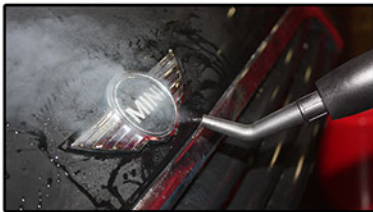

Replacement
rectangle foam w/Velcro
5-Pak



PODRF

Replacement
half moon foam w/Velcro
10-Pak



PODHMF

Replacement
circle foam w/Velcro
10-Pak



PODCF

Replacement
Cap
(x1)



PODCAP



As Recommended By



The Benefits of a "WetEdge" Squeegee:

- True Professionals use the Wet Edge!
- Teflon edge glides and cuts across media easier than the standard squeegee.
- By applying water to the Wet Edge side, it allows squeegee to glide over media without scratching laminate. It also reduces friction.
- Wet Edge material goes all the way to edge of squeegee to allow installation in tight areas. We use this almost like a paint brush.
- Helps when laying die cut or cut vinyl to vehicles without scratching painted surfaces.

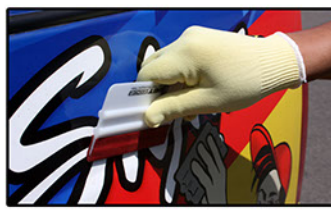

**WetEdge
Magnet
Squeegee**

WetEdge Squeegee WES
WetEdge Magnet Squeegee SQMAGWES

ALUMALITE SQUEEGEES

- Light weight aluminum construction
- Use for small and large applications
- Great for large format installs on windows - vehicles and any large surface window - walls - floors etc.
- Available in 6 sizes up to 50" wide
- Sooper - Glide felt edges for smooth application with no harm to sign or substrate



See page 28 for more info.

MORE INFO: 1-800-367-6526 • www.okpaper.com



The most ergonomically correct squeegee in the world!
 The Squeegee Evolved 360, with our ergonomic design and functionality allows users to not only grip with less strain to the hand itself but gripped in any position during a typical installation.
 Kit comes complete as shown with One handle and 3 Quick Change Blades.

Restylers Kit

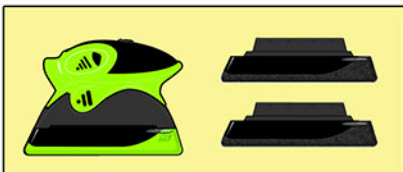

1 Complete Handle with 1 (one) Standard Blade + 2 Kit Blades

Part #: SE360R

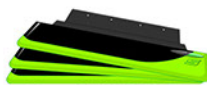

Part #: SEBP3S

3 Blade Pack-Green (HARD) rigid blades for everyday uses in vinyl application. Low flexibility designed to maximize downforce pressure on any surface, but not to be used on vinyl without transfer tape.



Part #: SEBP3R

3 Blade Pack-Black (SOFT) semi-rigid blades with thermally bonded micro-fibers for curved surfaces where blade flexibility is needed. Gives maximum pressure without drag.

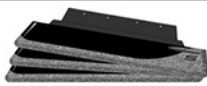

Part #: SEBP3W

3 Blade Pack-Charcoal (MEDIUM) rigid blades with thermally bonded micro-fibers for most flat surfaces where less blade flex is needed. For mild curves.

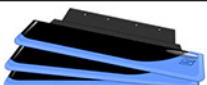

Part #: SEBP3TB

3 Blade Pack-Blue (HARD) rigid blades for everyday use in all flat window tint applications.

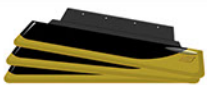

Part #: SEBP3TG

3 Blade Pack-Gold (MEDIUM) stiffness semi-rigid blades offering more flexibility for curved vehicle windows. Gives smooth consistent pressure without drag, safe for all tint films.

Window Tint Kit

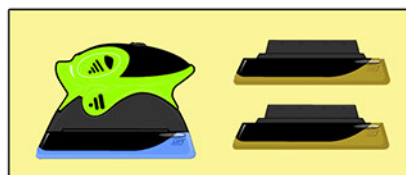

1 Complete Handle with 1 (one) Standard Blade + 2 Kit Blades

Part #: SE360T

Magnet Squeegee



SQMAG

Squeegee Brayer Combo Tool



SQBRYR

Felt Blocks



FBLOCK

4" & 6" Plastic with Felt Squeegee



**SQFLT6
SQFLT4**

4" & 6" Teflon Squeegee



**SQTEF6
SQTEF4**

Silver Nylon Squeegee



SQNYLN4

4" Gold Nylon Blend Squeegee



SQ4G

4" Soft Flex Squeegee

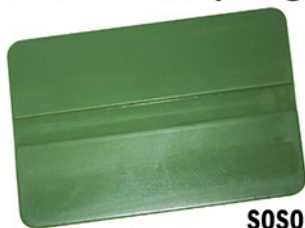

SQS0FT4

12" Squeegee

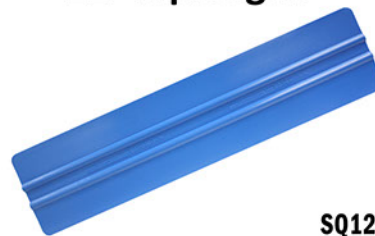

SQ12

5" Squeegee



SQ5S

4" Felt Buffers Self-adhesive

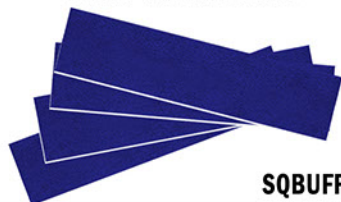

SQBUFF4

6" Squeegee Sleeves



SQSLEV6

4" Tranparent Squeegee



SQSTIF4

4" Standard Orange Squeegee



SQ4S

12" Rubber Blade Squeegee



SQRB12

TEFLON SQUEEGEE TAPE

- Teflon tape that can be applied to the edges of most any sized squeegee
- Provides increased speed and makes the squeegee "glide" smoothly over most film and print media surfaces
- 1" x 18 Yds Roll

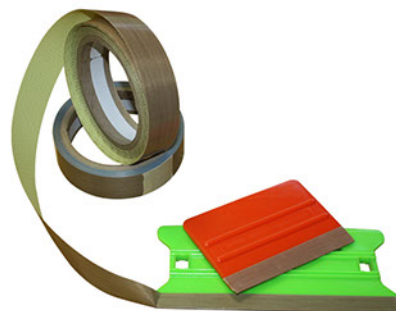

TEFTAPE1

SQUEEGEE SHARPENER

Maximize the Life of Your Application Squeegee / Hard Card Window Film Squeegee!
 An ideal way to maintain a sharp edge on hard cards and other squeegees is to use our Squeegee Sharpener. With one or two strokes your squeegee edge is restored to the same condition as when you first bought it.

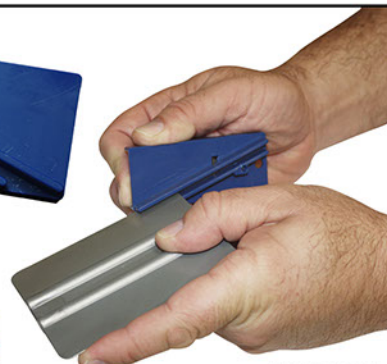

SQSHARP

MORE INFO: 1-800-367-6526 • www.okpaper.com

LIL' CHIZLER

The Lil' Chizler's unique design enables it to remove stickers and vinyl letters easily. Make sure area is free of dust & debris and it will not scratch... even plexi-glass and clear coat paints.



LILCHZL

THE G-N-G SQUEEGEE

- Sturdy 2-Piece Construction
- Interchangeable blades easily, snap in and out
- Firm ergonomic hand grip
- Yellow Grip-N-Glide for window film installations
- Orange Grip-N-Glide for paint protection film vinyl graphics and Wrap Films.



For Window Films



SQGNGY

For PPF & Wraps



SQGNOR

GNG Replacement Blade
Yellow



GNGBLADEY

GNG Replacement Blade
Red



GNGBLADER

EZ REACH ULTRA

Designed specifically to get at the corners of quarter glass windows, you'll also reach for it again and again to put down those little corners of film in hard to access areas.



SQZR

SPEED WINGS

- Durable and comfortable
- Contoured blade with unique tips
- Makes easy work for difficult corners
- Glides easily across all films surfaces
- A must have tool
- 3 densities and 3 sizes available

4" - 6" - 8" FIRM
Speed Wing Green



SQSWG4
SQSWG6
SQSWG8

4" - 6" - 8" MEDIUM
Speed Wing Yellow



SQSWY4
SQSWY6
SQSWY8

4" - 6" - 8" SOFT
Speed Wing Red



SQSWR4
SQSWR6
SQSWR8

TEFLON HARD CARDS

- The perfect window film application tool
- Available:
 - Blue - Soft
 - Black - Medium
 - White - Hard

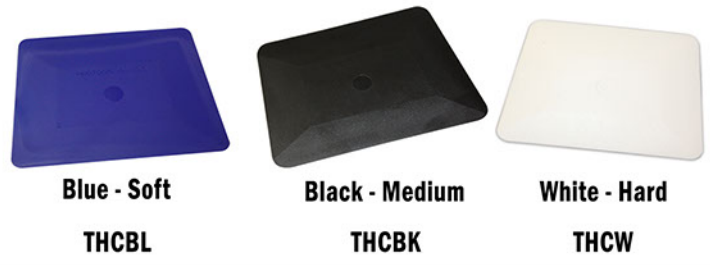

Blue - Soft
THCBL

Black - Medium
THCBK

White - Hard
THCW

GATOR BLADE

- Sharp but won't scratch the surface
- Safer and easier to use than razors
- Installers - Applicators and Detailers choice



SQGATOR

STROKE BLADE

Another of the Doctor Squeegee line but this time with a unique shape and reach for window tinting and vehicle wrapping.



SQSTROKE
Replacement Blade STROKEBLADE

CONTOUR SQUEEGEE

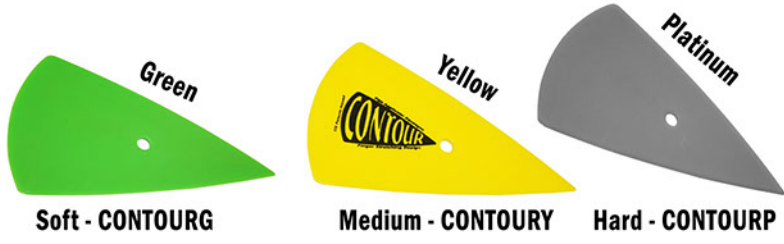

Soft - CONTOURG

Medium - CONTOURY

Hard - CONTOURP

- Curved edges to match these concave surfaces
- Use for window tint - vinyl graphics PPF and Vehicle Wraps
- Works on glass or painted surfaces
- Elongated triangular shape gets into all those hard to reach spots

DOCTOR SQUEEGEE

- Innovative Multi-Purpose Squeegee
- Modern H-Tech Unique Design
- Comfortable Handle and Quick-Change Blade System



SQDOCR

SQDOCY

SQDOCB

Replacement Blades



DOCBLADER

DOCBLADEY

DOCBLADEB

QUICK FOOT SQUEEGEE

- Stiff squeegee with handle medium reach
- The perfect in-between tool slim and trim



SQQFOOT

SLIM FOOT SQUEEGEE

- Has a soft rubber handle with 15 inch reach to get down in to back windows
- Slim design allows it to get into more spaces



SQSFOOT

MORE INFO: 1-800-367-6526 • www.okpaper.com

LITTLE FOOT SQUEEGEE

We took the unique blade shape of the Big Foot and removed the handle, to create a series of hard card/squeegee tools that bring a whole new angle to quick and easy applications.

- Blue** - Soft Plastic Squeegee - 6"
- Red** - Medium Plastic Squeegee - 6"
- Yellow** - Medium Plastic Squeegee - 6"
- Black** - Hard Plastic Squeegee - 6"



Blue - Soft
SQLFOOTBL



Red - Medium
SQLFOOTR



Yellow - Medium
SQLFOOTY



Black - Hard
SQLFOOTBK

ROLLEPRO

The faster, safer, easier way to apply vinyl film over rivets.



* for more info see page 42 RPRO

POD

PRESSURE ON DEMAND SYSTEM

"A MUST HAVE" FOR EVERY SHOP



* for more info see page 35

POD

THE G-N-G SQUEEGEE

- Sturdy 2-Piece Construction
- Interchangeable blades easily, snap in and out
- Firm ergonomic hand grip



For Window
Films

SQGNGY



For PPF
& Wraps

SQGNR

* for more info see page 39

ROLLEPRO

ROLLEPRO applicators are designed to roll over vinyl covered rivets and contours in seconds. The RollePro's ergonomic design and specially formulated, heat resistant wheel brings speed and comfort to the once time-consuming application process.



RPRO

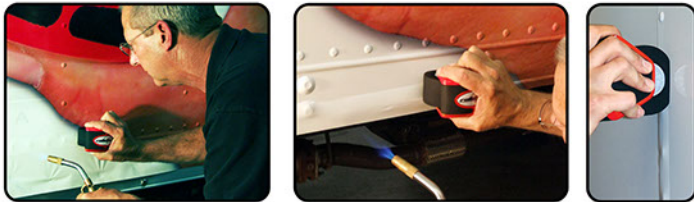

The faster, safer, easier way to apply vinyl film over rivets.

Replacement Wheel RPROW

MOBILE WRAP LIFT



Get to all those hard-to-wrap places without breaking your back!

The ImageOne Impact portable mid-rise lift is a great way to increase the productivity in a shop. It's like having a service bay anywhere, indoors or out. The motor is conveniently mounted to a heavy-duty tow dolly, making it easy to move and operate on almost any solid surface.

Maximum Capacity	6,000 lbs
Overall Width	39-1/2"
Overall Length	7' - 10"
Min Lowered Height	5-1/2"
Max Raised Height	53-1/4"
Maximum Lifting Height	56-5/16" (with adapter)
Lift Time	45 seconds
Power Requirement	110v AC - 60 Hz, 1 Ph 20A
Shipping Weight	930 lbs



KEY FEATURES:

- Heavy duty tow dolly provides flexibility to service vehicles anywhere in your shop
- 7 locking positions allow technician to work at an ergonomic height to increase productivity and minimize fatigue
- Electric motor mounted on tow dolly provides convenience and ease of maneuverability
- Single push button power unit with release valve provides convenience while lifting and lowering vehicle
- Slip-on rubber pad adapter kit with height extension accommodates high profile and lifted vehicles
- Sliding/rotating arm design accommodates meeting pick up points on a full range of vehicles

WRAPLIFT

MORE INFO: 1-800-367-6526 • www.okpaper.com

Hot Shot

• INFRARED HEATING UNIT •

FOR USE IN:

- VEHICLE WRAPS • RESTYLING
- COLOR CHANGE APPLICATIONS

Infrared heating units for softening films and breaking the films' memory during pre-and post-heating of vinyl films. These Infrared heating units are all designed for long life in the vehicle industry. You can have a wide area self-standing Infrared heater to dramatically speed up your installs and pre-and post-heating while giving you both hands free to work your film install. Standard 110V Plug



- 18" Head moves Vertical + Horizontal
- Up + Down • Instant on heat
- 1000 watt Short Wave Halogen
- Includes rolling stand
- Replacement Bulb - Part# HS1000XBULB
- 20Lbs



Head tilts Up or Down

Horizontal or Vertical

HS1000X

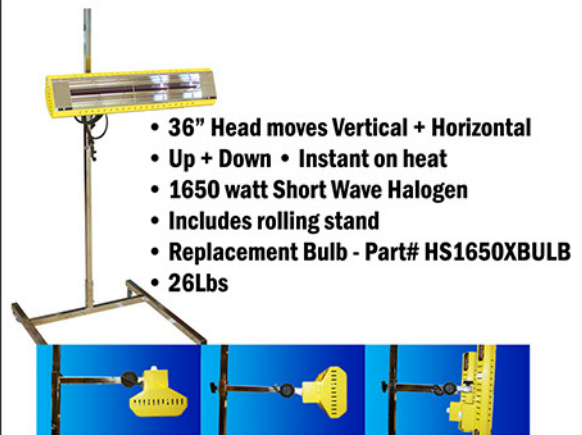

- 36" Head moves Vertical + Horizontal
- Up + Down • Instant on heat
- 1650 watt Short Wave Halogen
- Includes rolling stand
- Replacement Bulb - Part# HS1650XBULB
- 26Lbs



Head tilts Up or Down

Horizontal or Vertical

HS1650X



- 36" Head moves Vertical + Horizontal
- Up + Down • 2000 watts - Medium Wave Halogen
- Includes rolling stand
- Replacement Bulb - Part# HS2000XBULB
- 26Lbs

(240V - Euro Model Available)



Head tilts Up or Down

Horizontal or Vertical

HS2000X



- 36" Head Horizontal use only
- Up + Down • 1500 watts - Medium Wave Halogen
- Includes rolling stand
- Replacement Bulb - Part# HS1500BULB
- 24Lbs

(240V - Euro Model Available)

HS1500



- 2 - 36" Heads Horizontal use only
- Up + Down
- 2 - 1500 watts heads - Medium Wave Halogens
- 3000 total watts
- Includes rolling stand
- Requires 2 separate plug-in circuits
- 35Lbs

(240V - Euro Model Available)

HS3000

**VEHICLE BODY
MOLDING REMOVAL TOOLS**

5 pc kit



Excellent basic Molding removal set for any sign shop, vehicle wrap and/or paint protection installation shop and car enthusiast!
Includes 5 distinctive tools for the easy removal of body fasteners.

MOLD5

BODY CLIP SET

This set gives you a tool for almost any door using a push pin or panel clips type. Specially designed for removal of push pins with center locking pin. Quickly removes plastic anchors that have center pins without damage to pins or anchor.



BC3

**VEHICLE BODY
MOLDING REMOVAL TOOLS**

11 pc kit



- Deluxe 11 piece HD-Removal Kit with canvas storage case
- All necessary tools to remove door panels, trim trips, body building and interior panels
- Plastic tools will not mar or scratch surfaces
- All the tools you need to get the job done right and fast

MOLD11

PANEL CLIP PLIERS

For use in most door panel clip removals. These durable panel clip pliers are a must-have tool for vehicle wrap and color change installers looking to get that "is it painted" look!

The clip pliers feature a better support under the clip to remove panel clips without damage and a cushion grip handle for comfort.



- Cushion grip handle provides additional comfort
 - Won't damage panel clips
- Use with Honda, Toyota, GM, Ford and Chrysler
 - Weight: 0.57 lbs.

PCP

MORE INFO: 1-800-367-6526 • www.okpaper.com

THE HANDLER - VEHICLE WRAP & WINDOW TINT FILMS CUTTER



FH60 60" Handler
FH72 72" Handler

- Minimize waste and improve efficiencies with Vehicle Wrap Films and Window Tint Films.
- Comes in 60" and 72" Width
- Used by professional Vehicle Wrap Shops and Window Film Installers
- Reduce waste, and increase speed while cutting down film for installation.
- Both Handlers will cut any width roll up to their maximum width 3" core
- Comes with two adjustable cutting heads for slitting to your desired width.

Table Frame Mount



Fits 60" & 72" Handler

TBLHNDLRMT

Universal Mount



Fits 60" & 72" Handler

FHM6072

Mounting Options:

Table Frame Mount

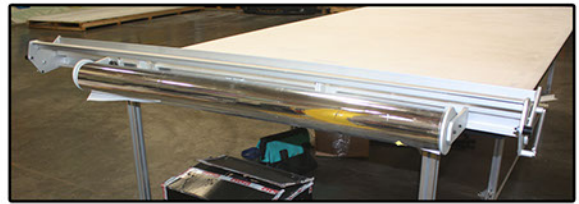
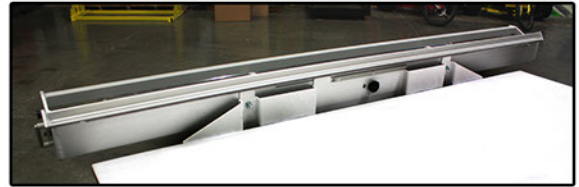

Ladder Mount



Universal Mount



MOBILE WRAP TOOL & DETAILERS CART

The ultimate add on to our "Handler" film cutting tool for tint and color change films. Also great for holding all your vehicle wrap tools allowing the wrap technician to bring the cart to the car and keep everything needed close to the job!

- The ultimate cart for use with the ImageOne Impact "Handler" film cutting tools.
- Rolls right into your work area for greater efficiency
- Keeps supplies handy and techs on the job
- Materials and supplies in full view from any angle
- Facilitates easy-to-use bar code system; tags provided
- Enables repair and process controls for consistent quality, time after time
- Powder coat finish
- Lifetime Warranty
- 22"L x 35"W x 67"H
- 101 lbs



INMDC

Universal Mount



Fits 60" & 72" Handler

FHM6072

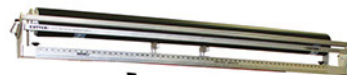

FHM6072

Showing The Handler mounted to our Mobile Wrap Tools Cart Using Bracket

* Part# FHM6072 (not included)



See page 45 - The Handler



MOBILE RACK HOLD 16 ROLLS LARGE FORMAT MEDIA

Organize your Rolls of Media & Banner Material

- All Steel Construction
- Bright Yellow
- Powder Coated Finish
- Easy Roll HD Locking Wheels
- Instructions Included
- Add your choice of 1" diameter rods (not included)



NEW

See page 14

SPECS:

- Length 62"
- Width 25"
- Height 62"
- Off Ground 5"

Part#	Description
MMR1600	Mondo Mobile Rack
RTCT20	Rubber Tips (20 Pk) Fits 1" pipes
RTCT21	Rubber Tips (20 Pk) Fits 1 1/16" pipes

MORE INFO: 1-800-367-6526 • www.okpaper.com

RIVET WHEEL

This uniquely designed pin wheel allows installers to put air release holes (never use knife slits) into an entire strip of a Big Rig trailer to make your installs much faster and easier than ever before.



RW

THE TAPE THING

- Magnetic Tape Holder
- 2 different sizes 3/4" & 1.5"



TTHING75
TTHING150

RIVET BRUSH

Made of stiff bristle synthetic fiber, the rivet brush helps form flexible vinyl over the rivet surface.



RB

PLASTIC PRY TOOL

A non-scratch version of our Pry Tool for use on most vehicles rubber window seals and gaskets as well as stubborn body moldings.



PPT

WINDOW PERF GAP KNIFE

This twin parallel blade knife allows for cutting strips of vinyl or gaps between the window seals and the window perf for longer life window perf installs.



WPKNIFE
WPKBLADE

RETRACTABLE WEEDING TOOL

Aluminum retractable Bubble Popper Weeding Pen with pocket clip used for making holes, also as a marking point in leather, paper, wood, plastic, etc. .31 x 5in - .8 x 12.7cm Made In USA



WEED30

BUBBLE POPPER

The right tool for the job and easy to hang on to since it clips to your shirt pocket like a "ball-point pen". Retracts and protracts like a "ball point pen" also.



BPOP

Replacement Tips BPR

STAINLESS STEEL PRY TOOL

Great for use on very firm and/or stiff rubber window seals and gaskets as well as stubborn body moldings.



SSPT

MORE INFO: 1-800-367-6526 • www.okpaper.com

Xtreme MAGZ

"YOUR XTRA HAND"

- A Must for Every Shop and Installer
- Make Applying Vinyl and Wraps EZ
- Large 1 5/8" Diameter Sooper Soft Rubber Coating Will NOT Harm Your Graphics or Substrates
- Bright Neon Colors Make them EZ to Locate
- Use in Place of Masking Tape to Position Graphics



XM6
(6 pack)
Low Profile



XM66
(6 pack)

MEGA MAGZ

- 3.5" Black Rubberized base
- Super Smooth to resist dirt collection
- Offers 50 + Lbs of pull anchoring force
- 5.25" Long comfort grip rubber handle
- EZ to use will not harm your surface
- "Mega Magz" are faster, safer and easier

Single Pak MM1
2-Paks MM2



Extra Strong + Extra Large + Multifunctional = "Mega Magz"

HEAT GUN HOLDER

Extra Strong Magnet
Black Rubberized Super Smooth to resist dirt collection



HHMAG

LOW PROFILE

Vehicle Wrap Magnets

- Bright Yellow "Low Profile" Magnets EZ to find
- Awesome for vehicle wraps and graphic installs
- Use individually or in line for a hinge method
- 28 Lbs. of pull each will hold up almost anything
- Completely rubber coated will not harm your surface
- No need for extra felt strips



(2 pack) XMLP

MORE INFO: 1-800-367-6526 • www.okpaper.com

WRAP KNIFE

- Made specifically to cut through just the liner of any pressure sensitive vinyl films.
- This knife will cut through only the paper backing of a self-adhesive vinyl.
- Made with a solid steel shaft and special coating on the bottom surface
- Replacement blades available.



10-Blade Replacement Pack

WCKNIFE
WCBLADE10

TWIN WRAP KNIFE

- Same as the Standard Wrap Cut Knife but has two cutting blades
- The Twin Blades cut a 7/8" strip of liner for easy Application



NEW



10-Blade Replacement Pack

WCKTWIN
WCBLADE10

Faster, easier wraps and digital media work, guaranteed!



The WrapGlove is specifically made for the Wrap/Decal applicators.

- A unique blend of fibers that has taken years to develop
- They don't shed—no lint or fibers on your adhesive
- They don't transfer your skin's oils
- They can be used to handle the adhesive side of digital and wrap films
- Reduce/remove friction when hand cutting vinyl

All of these improvements make the WrapGlove "Black" the application glove of choice to the Wrap Industry.



CREATED BY PROFESSIONALS...
Professionals use the best tools for their trade.



Part #	Description
WG1S	1 Pair - Size: Small
WG1M	1 Pair - Size: Medium
WG1L	1 Pair - Size: Large
WG1XL	1 Pair - Size: XLarge



(1 pair)

LOW COST MEDIA HANDLING GLOVES

When handling print media and substrates, taking time with the extra special precautions ensure your precious memories are protected and preserved.

(1 pair)

MGLOVEM MGL0VEL MGLOVEXL
MEDIUM LARGE XLARGE



Features:

- Prevent getting fingerprints and smudges on the print, substrate, media or film
- Ensure your expensive print medias are protected from oil and sweat transfer from your hands

ONE SIZE FITS MOST!



(1 pair) GGLOVE

MORE INFO: 1-800-367-6526 • www.okpaper.com

EMBLEM REMOVAL TOOL

- ER-1 Emblem Removal Tool comes with a set of brightly colored custom designed ergonomic handles.
- The cutting cord allows you to cut through automotive grade adhesives used on many vehicle's emblems and logos without risk of damaging a vehicle's paint or the emblem itself.
- Replacement cutting cords are sold in 100-paks



ER1
100 Cords Pack ERC100

OPEN TOP WRAP HAT

- 4 Bright White LED's
- On/Off switch under bill front
- Uses 4 easy to change CR2032 batteries
- Comfortable reinforced sure-dry head band
- Wears like a tennis headband



WHV

BASEBALL STYLE WRAP HAT

- 4 Bright White LED's
- On/Off switch under bill front
- Uses 4 easy to change CR2032 batteries
- Comfortable reinforced sure-dry head band
- Wears like a baseball hat



WHB

SOOPERBRIGHT PRO WRAP HAT

- 6 Bright White LED's
- 2 on, 4 on, all 6 on, multi-switch under bill front
- Uses 3 replaceable AAA size batteries
- Comfortable reinforced and padded head
- Wears like a round top hat.



WHP

MAGNETIC WRIST BAND

- Embedded with super strong magnets for holding OLFA knives and many other metal tools
- Ideal for most vehicle wrap and installation projects.
- Wristband can be attached to ladders, metal shelves, etc.
- One size fits all.



MAGWB

MAGNETIC BELT POUCH

- Made of durable 1,680-denier ballistic polyester
- Adjustable to left, right or onto another tool case.
- Magnetized to store OLFA knives, small tools and reduce metal fastener spills
- Compatible with most tool belts



MAGBP

MAGNETIC BELT CLIP

- Wristband and belt clip are embedded with super strong magnets for holding screws, wrenches and small tools.
- 360° rotational belt clip.
- One size fits all.



MAGBC

MAGNETIC SUSPENDERS

- Polyester Magnetic Work Suspenders use double-layered reinforced polyester
- Suspenders include a super strong detachable magnet for holding
- Adjustable straps
- Built-in cell phone pouch



MAGSUS

MORE INFO: 1-800-367-6526 • www.okpaper.com

INFRARED THERMOMETER WITH LASER

- Measurement Range: -60 to 550 °C (-76 to 1022 °F)
- Operating Range: 0 to 50 °C (32 to 122 °F)
- Resolution (-9.9 to 199.9 °C): 0.1 °C/0.1 °F, otherwise 1 °C/1 °F
- Response Time (90%): 1 sec
- 12:1 Distance to Spot Size
- Battery Life: Typ. 18, min 14 hours continuous use - Weight: 1.75 lbs.



IRGATD

DUAL TEMPERATURE HEAT GUN KIT

- Two Heat Settings; 700 °F & 925 °F
 - Watts - 1000 Low/1500 High
 - Three Position Rocker Switch; High/Off/Low
 - UL & CUL Listed
- Includes:
- Dual Temperature Heat Gun
 - Reduction Nozzle
 - Reflector Nozzle
 - Large Deflector Nozzle
 - Small Deflector Nozzle
 - Black Plastic Case
 - Weight: 2.00 lbs.



HGDT

DIGITAL VARIABLE TEMPERATURE HEAT GUN KIT

- "Soft Touch" Control for more exact temperature setting
- High and Low settings each have 6 temp. settings - 12 heat settings total
- Total temperature range from 250°F to 1200°F
- Watts - 1500
- LED Display clearly indicates level of heat emitting
- Patented 80 second automatic cool air flow to prevent accidental burns and to extend life of heating element
- Kit includes four tips and plastic case
- Weight: 3.50 lbs.



HGDTV

INSTALLERS PEN



Adhesive Primer Applicator Tool

All vehicle wrap professionals know that primer 94 is a must to ensure the longevity and durability of a vehicle graphic. Applying Primer 94 can be a time-consuming and often messy task.....until now.



IPEN

SEALITPEN



Here's a fast, simple answer to your edge sealing problems with outdoor and some indoor vinyl applications that require edge protection from washing, polishing, and excessive physical contact.



SEALIT

WRAP PRO TUCK & GROOVE TOOL KIT

7-piece tool kit for getting under any vehicle's rubber gasket seal or window molding. Also for getting in-between body panels, deep crevices and tight spots during a vehicle wrap or color change.

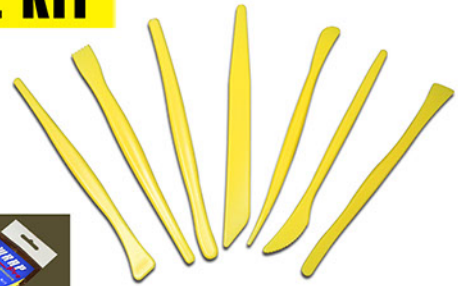

TG7

SOOPER CHAIR - DELUXE

Manufactured from strong, lightweight steel. You will enjoy the comfort and back support of these seats for hours on end. Multiple storage utility compartments and a handy parts tray let you load these babies up with wrap tools.



SCDLUX

RACER SHAPE

Sooper Thick

Wrap Film "Show-Off"

Looks like a race car and shows every conformable possibility that your customer might have on their vehicle.



4" X 8"

WSRS

SOOPER CHAIR - ERGO

Is the first of its kind to give you complete ergonomic comfort, while maintaining a stable working position. The weird, but remarkable, kneeling wrap chair won't slide around while wrapping and installing.



SCERGO

CONVEX BUBBLE SHAPE

Wrap Film "Show-Off" Sooper Thick

Great uniformed look when multiple colors are displayed. Shows both convex and concave application.



5" X 5" Radius

WSCBS

SOOPER CHAIR - HD BOX

Gives employees the ability to keep all their tools inside the chair's front & back tool trays. Has a padded seat cushion for comfort, welded steel frame, 3-Drawer toolbox with roller bearing slides.



SCHDBOX

HOOD SHAPE

Sooper Thick

Wrap Film "Show-Off"

The most well recognized shape for your customers to see. These mini vehicle hoods are perfect for showing a real race car or sporty automotive feel.

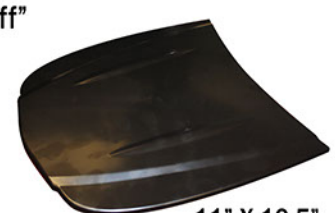

11" X 10.5"

WSHOOD

**Wrap Care
After Care - JP**

Cleans, Seals and Protects any brand of Gloss, Carbon fiber, Brushed Metallic, Chrome vehicle wrap and graphic signage films and more.



WCAC32

**Wrap Care
After Care - JP Matte**

Specifically for the unique surface of Matte and Satin surfaces. Cleans, Seals and Protects any brand of Matte and Satin finish returning your original matte finish.



WCACM32
Gallon WCACMGAL

**Adhesive & Heavy Duty
Surface Cleaner - JP**

Adhesive & Heavy Duty Surface Cleaner-JP is specially developed for removal of adhesives & other hard to remove contaminants on most solid substrates and vehicles without risk of damage to painted finish.



AR32
Gallon ARGAL

**WRAP
VIDEOS**
By Justin Pate

**3-Pack
Bundle**



This is a very well-produced HD DVD set of real wrap lessons that simply work great; by one of the most experienced wrap installers in our industry. Study Justin Pate's unique "UGIS" system. It's not just how to install a wrap. It is from preparation to post heating, showing "all the RIGHT things to do".

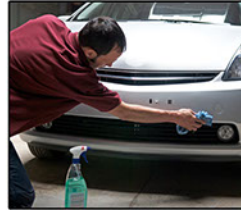

JPDVD3PK

TABLE FRAMES

**ALUMINUM FRAMES, MOBILE WITH
HD LOCKING WHEELS**



TBLF

(Shown with 5'x10'
Table Top NOT Included)



TBLF2448



TBLFEXT

See pages 25 & 26 for
more info.

ALUMALITE HD LINER

Cut Tool

Is a precision, hand-held device utilizing a standard single edged razor blade. The blade depth adjustment is as simple as using a screw driver, which can control the depth of cut to less than a thousandth of an inch.



SEE PAGE 28

Blades - 650506
100 Pack Dispenser **ALHDLCT**

POCKET LINER

Cutting Tool

This smartly engineered, innovative tool offers a unique way to cut only the liners of your substrates and not the film. The auto Pressure Control System adjusts the cutting pressure to help prevent damage to the material beneath.



Blades - LCTB
5 Pack **LCT**

ECONOMY LINER

Cut Tool

Works by pushing the bottom portion of the tool underneath the liner (in-between liner and adhesive film) and then pushing through to the end of your cutting needs. This tool will continue to slightly separate the liner from the adhesive film but cut only the liner as it is pushed through.



LCTECO

TWIN WRAP KNIFE



- Same as the Standard Wrap Cut Knife but has two cutting blades
- The Twin Blades cut a 7/8" strip of liner for easy Application
- Made specifically to cut through just the liner of any pressure sensitive vinyl films.
- This knife will cut through only the paper backing of a self-adhesive vinyl.
- Made with a solid steel shaft and special coating on the bottom surface



WCKTWIN
10-Blade Pack **WCBLADE10**

WRAP CUT KNIFE

- Made specifically to cut through just the liner of any pressure sensitive vinyl films.
- This knife will cut through only the paper backing of a self-adhesive vinyl.
- Made with a solid steel shaft and special coating on the bottom surface
- Replacement blades available.



WCKNIFE
10-Blade Pack **WCBLADE10**

SNAPPY SAFE CUTTER

One of the most versatile tools ever designed for cutting paper, cloth and plastic films. A great little tool to have around the shop and in your tool box.



SCUT

CORO CUTTER

The best knife for cutting corrugated plastic sheeting.



COROCUT

PenBLADE®

With its unique, disposable pen-like design and retractable safety blade, Penblade knives are a cut above the rest. Medical grade non-sterile super sharp blades offer extra-long life and exceptionally easy cutting of vinyl, banner, PPF, window tint films and most rigid sign substrates as well.

3 Blade styles to choose from.



AVAILABLE
IN BLADE
SIZE No.
10, 11 & 15

PBLADE10
PBLADE11
PBLADE15

CRAFT AND HOBBY TOOL GYRO-CUT

Designed to easily cut thin sheet materials such as paper, thin card up to 240gsm, vinyls, thin mylar sheet, masking material, decopatch, etc.

2-pak Replacement Blades

Hand held Knife



GCBLADE2



GCKNIFE

FOAMBOARD STRAIGHT CUTTER



Cut perfect straight edges on any depth of foamboard from 1/8" to 1/2".

FoamWerks Straight Cutter features adjustable blade depth, quick change blade clip, magnetic blade slot, on-board blade storage drawer and five blades.



Replacement blades WC-20

WC6001



SAFETY RULERS



The Sooper Edge is the premier safety ruler in the sign and graphics industry

Big Blue Safety Ruler is the one choice for the finishing room

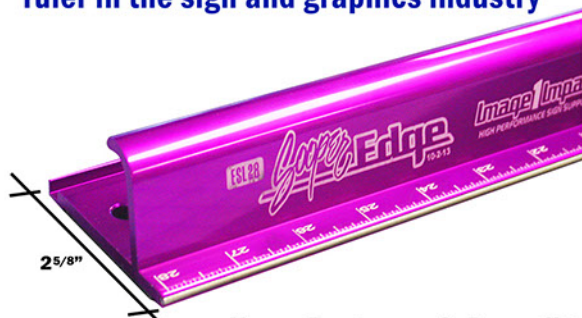

FOR MORE INFO
SEE PAGE 22

More Features & Benefits than any other Safety Ruler!

MORE INFO: 1-800-367-6526 • www.okpaper.com









Standard Duty Cutters

CUTTING TOOLS & BLADES

<p>Standard-Duty Cutter 180</p>  <p>Features a slide lock, pocket clip and Built in Blade snapper</p> <p>• Use Standard Duty Blades AB • ABB</p>	<p>PROLOAD Multi Blade Cutter PA2</p>  <p>Holds up to 5 blades in a sleek comfortable handle with automatic blade load feature and auto-lock blade. Comes with 3 UltraMaxBlades</p> <p>• Use Standard Duty Blades AB • ABB</p>
<p>Ultra-Slim Cutter SAC1</p>  <p>The Tool of choice for Sign Making and Graphic Artists. The Acute 30° angle easily cuts foam board, gator board, coroplast, plastics and more</p> <p>• Use Blades A1160B</p>	<p>Deluxe Stainless Steel Cutter SVR1</p>  <p>Slim Design, features a slide lock and pocket clip / blade snapper</p> <p>• Use Standard Duty Blades AB • ABB</p>
<p>Auto Lock Stainless Steel Professional Knife SVR2</p>  <p>For RH & LH users with auto-lock blade, pocket clip and blade snapper</p> <p>• Use Standard Duty Blades AB • ABB</p>	<p>Cushion Grip Standard-Duty Cutter XA1</p>  <p>Anti-slip cushion grip handle with auto-lock blade Pocket clip and blade snapper</p> <p>• Use Standard Duty Blades AB • ABB</p>
<p>High Quality Precision Knife AK4</p>  <p>Made for professionals with HandSaver cushion grip, perfectly balanced for right hand and left hand users</p> <p>• Use Precision Art Blades KB • KB4-S/5</p>	<p>Snap IT 'N' Trap IT DA1</p>  <p>Developed for professionals looking for a convenient way to snap-off and securely store their dull blade segment for increased on-the job productivity</p> <p>• Use Standard Duty Blades AB • ABB</p>
<p>Wheel Lock Utility Knife 300</p>  <p>This knife is larger than other 9mm utility knives, providing more leverage for tougher cutting projects.</p> <p>• Use Blades AB • ABB</p>	<p>Liner Cutting Tool LCT</p>  <p>Smartly engineered, an innovative tool that offers a unique way to cut only a single, top sheet of material or just the liner!</p> <p>• Use Blades LCTB</p>











REPLACEMENT BLADES - STANDARD DUTY BLADES

<p>AB AB10S (10 PACK) • AB50S (50 PACK) Stainless Steel</p> 	<p>KB (25 PACK)</p> 	<p>KB4-S/5 (5 PACK) KB4-S/100 (100 PACK)</p> 	<p>LCTB</p> 
<p>ABB ABB10B (10 PACK) • ABB50B (50 PACK) Carbon Blade, Double Honed 25% sharper</p> 	<p>A1160B (10 PACK) Acute Angle Snap off blades</p> 		







MORE INFO: 1-800-367-6526 • www.okpaper.com

Heavy Duty Cutters

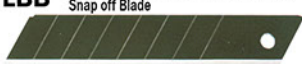

<p>Sign Materials & Package Cutter CL</p>  <p>With a ratchet-wheel blade lock, adjustable depth gauge and a flat cutting base for stability. Ideal for cutting CardBoard, Coroplast, Foam Board Gator Board and more • Use HD Blades LB • LBB • L-SOL</p>	<p>Rubber Grip Insert Utility Knife L2</p>  <p>Features a ratchet-wheel blade lock and anti-slip rubber grip insert for secure handling • Use HD Blades LB • LBB • L-SOL</p>
<p>Auto-Lock HD Cutter LAX</p>  <p>The snap-off cutter features automatic blade lock and a built-in hard metal pick for scoring corrugated plastics, bending and more • Use HD Blades LB • LBB • L-SOL</p>	<p>8" Arm Extra Heavy-Duty Scraper BSR200</p>  <p>Optimal size for centralized use on tough removal projects. Tool-Free Blade Change. Blades easy to replace • Use HD Blades BS • BSF</p>
<p>Plastic / Laminate Heavy-Duty Cutter PCL</p>  <p>A heavy-duty plastic/laminate cutter designed as a scoring tool for sheet plastics and laminates, enabling the precise breaking of plastic materials. • Use HD Blades PB-800</p>	<p>12" Arm Extra Heavy-Duty Scraper BSR300</p>  <p>Longer handle accommodates two-handed use for more leverage on large removal jobs. Tool-Free Blade Change. Blades easy to replace • Use HD Blades BS • BSF</p>
<p>Self-Retracting Safety Knife with Tape Slitter SK9</p>  <p>The tape slitter can be used to slit tape, as a scoring tool to customize boxes, and a screwdriver and staple-remover. For right and left-handed user. The safest tool in your shop • Use HD Blades SKB-2 • RSKB</p>	<p>Comfort Grip Utility Knife XH1</p>  <p>Offers a cushion-grip handle engineered of fiberglass conjoined with elastomer for chemical resistance and easy cleaning. • Fits any OLFA Extra Heavy-Duty Blade</p>
<p>Cushion Grip Ratchet-Lock Utility Knife NOL1BB</p>  <p>With a ratchet-wheel blade lock for extra control. Unlimited blade adjustment. Includes LB Blade. • Fits any OLFA Heavy-Duty Blade</p>	<p>SNAPit'N'TRAPit™ DL1</p>  <p>Developed for professionals looking for a convenient way to snap-off and securely store their dull blade segment for increased on-the job productivity • Fits any OLFA Heavy-Duty Blade</p>

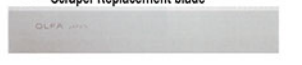
REPLACEMENT BLADES - HEAVY DUTY BLADES

<p>LB LB10B (10 PACK) • LB50B (50 PACK) Stainless Steel, Snap off Blade</p> 	<p>LBB LBB10B (10 PACK) • LBB50B (50 PACK) Carbon Blade, Double Honed 25% sharper Snap off Blade</p> 	<p>HB HB5B (5 PACK) High Quality Carbon Tool Steel Blade</p> 	<p>RSKB-2 RSKB210B (10 PACK)</p> 
<p>L-SOL LSOL10B SOLID BLADES (10 PACK)</p> 	<p>BS BS10B (10 PACK) • BSF6B (6 PACK) Scraper Replacement blade</p> 	<p>PB-800 (3 PACK)</p> 	<p>SKB-2 SKB210B (10 PACK)</p> 

MORE INFO: 1-800-367-6526 • www.okpaper.com







Specialty Cutters

CUTTING TOOLS & BLADES

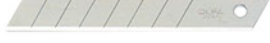
<p>Heavy Duty Compass Cutter CMP2</p> <ul style="list-style-type: none"> • Cut circles from 3" to 12" in diameter. • Great for cutting wind slits in banners • Adjustable pivot point for cutting through various thicknesses.  <p>• Use Heavy Duty Blades LB • LBB • L-SOL</p>	<p>7" Stainless Steel Scissors SCS2</p>  <p>Designed for precision cutting for consumer and industrial applications. Anti-slip serrated edge for superior cutting</p>
<p>45mm Deluxe Rotary Cutter RTY2DX</p>  <p>The most popular OLFA rotary cutter. Easily cuts through multiple layers of fabric, vinyl and textiles with precision accuracy.</p> <p>• Use Heavy Duty Blades RB45</p>	<p>Unique 4-Point Adjustable Blade Positioning SK10</p>  <p>Concealed blade safety knife featuring an adjustable blade positioning design which allows for 4 cutting points on a single-edge utility blade</p> <p>• Use Heavy Duty Blades SKB-10</p>
<p>Blade Disposal Can DC3</p>  <p>Handy Pocket-size Can for Quick and Safe Snap-off Disposal of OLFA Standard and Heavy Duty Blades</p>	<p>Blade Disposal DC4</p>  <p>Disposes Single-Edge - Utility Knife and Snap-Off Blades, Holds Approximately (30) 2-Sided Utility Blades And Up To 200 Snap-Off Blades</p>
<p>Reusable Blade Disposal Holster DC5</p>  <p>Convenient new way to safely snap and dispose of dull blade edges. Easily attach the DC-5 to a belt or tool-bag for portability. Two blade-snapping locations to accommodate left and right handers.</p>	<p>The largest of the OLFA rotary Cutters RTY3G</p>  <p>This tool is sharp enough to cut through difficult materials and up to 8 layers of fabric.</p> <p>• Fits RB60 Blades</p>

REPLACEMENT BLADES - SPECIALTY CUTTERS

<p>LBB LBB10B (10 PACK) • LBB50B (50 PACK) Carbon Blade, Double Honed 25% sharper Snap off Blade</p> 	<p>LB LB10B (10 PACK) • LB50B (50 PACK) Stainless Steel, Snap off Blade</p> 	<p>OLO OLO5B (5PACK) • OLO100B (100 PACK) Utility Blades, also Fits Safety Speed Cut • Keen Cut • Saw Trax Etc.</p> 	<p>RB60</p> 
<p>SKB-10 SKB1010B (10 PACK) The blade provide four cutting surfaces.</p> 	<p>L-SOL LSOL10B SOLID BLADES (10 PACK)</p> 	<p>SKB-2 SKB210B (10 PACK)</p> 	<p>RB45 RB455 (5 PACK) RB60-5 (5 PACK)</p> 

MORE INFO: 1-800-367-6526 • www.okpaper.com

EXCEL GRIP-ON KNIFE



Soft Grip Handle Hobby style Knife has 4 jaw machined aluminum chuck for secure blade positioning.



GRIPKNIFE



Replacement Blades #11

EXC11100

RETRACTABLE KNIFE-EXECUTIVE

Heavy Duty black aluminum retractable style knife for easy use in a shirt or tool pouch pocket.



EXEGRKNIFE



2-Blade Replacement Pack Executive Retractable

EXEGRB

RETRACTABLE KNIFE-DELUXE

Narrow silver aluminum retractable style knife for easy use in a shirt or tool pouch pocket.



DLXRKNIFE



2-Blade Replacement Pack Deluxe Retractable

DLXRB

REVO LOCK-BACK UTILITY KNIFE

Lightweight Lock-back handle utility knife with belt clip. Quick change blade mechanism. Blade safety guard included. Assorted colors.



EXCLBKKNIFE



Replacement Blades

EXCUTBLADE5
(5-Pak)



EXCUTBLADE100
(100-Pak)

SLIM BODY SNAP BLADE KNIFE

Slim metal framed snap blade knife with locking screw positioning.



EXCSLIM

REPLACEMENT BLADES



EXCSNAP100
(100-Pak)



30° Blades fits all brands of 9mm Knives

EX3010
(10-Pak)

EX30100
(100-Pak)

Single Edge Razor/Scraper Blade Dispenser /w Used Blade Storage Safe, pop-up blade dispenser and used blade safe storage.



650506
(100-Pak)

Sooper Graphics Shop Set-up Check List



Qty	Part#	Description	Catalog Page
	BTK1000	BannerTrak Banner Hanging system	05
	GGLOVE	Graphics Gloves	31
	MANO	Mano Press Grommet Press w/ 250 Clear grommets	18
	SR3000	Sooper Rounder Corner Rounder	21
	ESL28	28" Sooper Edge Safety Ruler	22
	ESL52	52" Sooper Edge Safety Ruler	22
	XJ4PAK	Aluminum Straight edge kit 4,5,6 and 8 foot lengths	23
	TS15BK	T-Square for Sooper Edge Rulers	22
	TA24	24" ProRoll Tape Applicator	24
	CM???	??? Size Xtreme Cutting Mat (size to match your cutting table)	26
	DR12AMT	Medium Tack Tacky Roller	31
	SR25GPO	Orange ScrapeRite plastic razor blades	32
	ST98933	Spinning Organizer tray	30
	XP56	3M Dispenser	30
	MR16	Mobile Rack for 3" cores (use MR12 for 2" cores)	15
	MJ1000	MondoRaxx Wall Rack	14
	SC50	Sooper Clips for Media Rolls	16
	ID12A	Asst Core ID Tags	16
	XMH6	Installer Magz	48
	Pick your Preference	Sooper Chair – Installer/Shop Chairs	52
	WG1	Wrap Gloves	49
	ER-1	Emblem Removal Tool	50
	WES	WetEdge Squeegees	36
	WCKTWIN	Wrap Cut Twin	49
	SQAL20	Alumalite Squeegees	28
	TPOUCH4	Tool Pouches	27
	CH4W	4-Pak Sooper Ceiling Hooks	4
	SLK3000	Linklip Chain link Mounts	10
	SH	Sooper Hinge A-Frame/Handle lit	4
	SHF	Sooper Hinge Feet	4
	SF1025B	¼" Spider feet	3
	SF1050B	½" Spider Feet	3
	SFJ1050B	½" Jumbo Spider Feet	3
	COROCUT	Coro Cutter	54

MORE INFO: 1-800-367-6526 • www.okpaper.com

INDEX

#

3M Tape Dispenser – Page 30
4 Pc Metal Blade Scraper Set - Page 33
4-Pak Sooper Ceiling Hooks – Page 4

A

Alumalite HD Liner Cutter – Page 28 -54
Alumalite Squeegees – Page 28
Alumalite Threaded Handle – Page 29
Aluminum Pole Banner Parts 1" – Page 7
Aluminum Pole Banner Parts 1.66" – Page 8

B

Banner Bond – Page 11
Banner Bond Ultra – Page 11
Banner Trak Kit – Page 5
Banner Trak Parts – Page 6
Big Gripper Blade Holder – Page 32
Black Wall Mount Bracket Kit – Page 7
Body Clip Set – Page 44
Bravo Aire Grommet Press – Page 18
Bravo Tabs – Page 13
Bubble Popper – Page 47

C

Clear Grommets Combo Kits – Page 20
Complete Weeding Kit – Page 23
Core ID Cards – Page 16
Coro Cutter – Page 54
Countour Squeegee – Page 40
Craft & Hobby Tool Gyro-Cut – Page 27 - 55

D

Designer's Layout Rulers – Page 23
Dies for Hiker & Stimpson – Page 19
Dies for Metal Grommets – Page 19
Dies for Plastic Grommets – Page 18
Dies for Sooper Rounder – Page 21
Doctor Squeegee – Page 40

E

Econo Air Grommet Press – Page 19
Economy Liner – Page 54
Emblem Removal Tool – Page 50
Excel Grip on Knife – Page 59
EZ Reach Ultra – Page 39

F

Fiber-Glass Pole Banner Spare Parts – Page 9
Floor Rack HD 44 Rolls 3" Core – Page 15
Foamboard Straight Cutter – Page 55

G

Gator Blade – Page 40
General Purpose Masking Tape – Page 11
Graphic Gloves – Page 31

H

Heat Guns – Page 51
Heater Holder – Page 48
Hot Shot – Page 43

I

Infrared Thermometer – Page 51
Installer Pen – Page 51

L

Lil' Chizler – Page 33 - 39
Linklamp – Page 10
Linklip – Page 10
Little Foot Squeegee – Page 41
Low Cost Media Handling Gloves – Page 31
Low Profile Magnets – Page 48

M

MagnAbracket - Page 3
Magnetic Belt Clip – Page 50
Magnetic Belt Pouch – Page 50
Magnetic Suspenders – Page 50
Magnetic Wrist Band – Page 50

Mano Hand Grommet Press – Page 18
Maxi Pod Banner Stand – Page 17
Mega Magz – Page 48
Mega Tape – Page 13
Metal Grommet Size Guide – Page 19
Metal Grommets – Page 19
Mobile Multi Use Table Frame – Page 26
Mobile Rack – Page 46
Mobile Rack 12 Spindles 2" Core – Page 15
Mobile Rack 16 Rolls – Page 14
Mobile Rack 16 Spindles 3" – Page 15
Mobile Wrap Lift – Page 42
Mobile Wrap Tool & Detailers Cart – Page 46
Molding Removal Tools – Page 44
Mondo Raxx Jumbo
Banner Material Storage – Page 14
Mondo Raxx Jumbo Media Storage – Page 14
Mondo Raxx Kit – Page 14

O

Olfa Heavy Duty Cutters – Page 57
Olfa Specialty Cutters – Page 58
Olfa Standard Duty Cutters – Page 56

P

Panel Clip Pliers – Page 44
Pen Blades – Page 55
Pick N' Hook - Page 2
Plastic Grommet Size Guide – Page 18
Plastic Grommets – Page 18
Plastic Pry Tool – Page 47
Pocket Liner – Page 54
POD Steamer – Page 35
POD Steamer Accessories – Page 35
Pole Banner Double Kit Aluminum 1" – Page 7
Pole Banner Double Kit Aluminum 1.66" – Page 8
Pole Banner Double Kit Fiber-Glass – Page 9
Pole Banner Single Kit Aluminum 1" – Page 7
Pole Banner Single Kit Aluminum 1.66" – Page 8
Pole Banner Single Kit Fiber-Glass – Page 9
Pole Tape – Page 11
Pole Tape – Page 13
Poly Tabs – Page 13

Power Clips – Page 13
Power Punch – Page 13
Power Tabs – Page 12
Power Tape – Page 12
Pro-Roll Tape Applicator – Page 24

Q

Quick Foot Squeegee – Page 40
Quick Release Clamp 1" – Page 17
Quick Release Stainless Steel Straps
& Cable Ties UV – Page 9

R

Replacement Blades/Excel – Page 59
Replacement Poles – Page 8
Retractable Knife Deluxe – Page 59
Retractable Knife Executive – Page 59
Retractable Weeding Tool – Page 47
Retractable Weeding Tools – Page 24
Revo Lock-Back Utility Knife – Page 59
Rivet Brush – Page 47
Rivet Wheel – Page 47
Rollepro – Page 42
Roller Squeegee Brayers – Page 30
Rubber Tips – Page 14
Ruler Accessories – Page 22

S

ScrapeRite – Page 32
SE360 Squeegee – Page 37
SealitPen – Page 51
Shapes Wrap Film "Show-Off" – Page 52
Sibolt – Page 10
Sign Clip – Page 3
SignAbracket – Page 3
Slim Body Snap Blade Knife – Page 59
Slim Foot Squeegee – Page 40
Snappy Safe Cutter – Page 54
Soft Grip 8" Scissors – Page 27
Sooper Ace Grommet Press – Page 19
Sooper Brackets – Page 2
Sooper Chairs – Page 52
Sooper Clip – Page 16
Sooper Edge Safety Ruler – Page 22
Sooper Feet – Page 4
Sooper Hinge – Page 4
Sooper Pole Mount – Page 2
Sooper Rounder – Page 21

Sooper Strong Hook & Loop – Page 11
Sooper Tack Rollers – Page 31
Speed Wings – Page 39
Spiderfeet – Page 3
Spinning Organizers – Page 30
Squeegee Sharpener – Page 38
Squeegees – Page 37
Squeegees – Page 38
Stainless Steel Pry Tool – Page 47
Stroke Blade – Page 40
Super Bracket 90° – Page 2

T

Table Frames – Page 25
Tag-It Bracket – Page 2
Teflon Hard Cards – Page 40
Teflon Squeegee Tape – Page 38
The Big Blade Jumbo Size
Plastic Razor Blade – Page 33
The Big Blue Safety Ruler – Page 22
The G-N-G Squeegee – Page 29 - 39
The Handler Film Cutter – Page 45
The Magnet Tool Pouch – Page 27
The Tape Thing – Page 47
The Ultimate Banner Stand – Page 17
The Ultimate Laminator Tool Kit – Page 31
The Yellow-Black Tool Pouch – Page 27
Trade Show Banner Backdrop Kit – Page 5
Twin Wrap Knife – Page 49
Twin Wrap Knife – Page 54
Twist N' Hook – Page 2

W

Wall Rack HD 20 Rolls 3" Core – Page 15
Weeding Pen – Page 24
Wet Edge Magnet Squeegee – Page 36
Wet Edge Squeegee – Page 36
Wind Rider – Page 3
Window Gap Knife – Page 47
Wrap Care Products – Page 53
Wrap Cut Knife – Page 54
Wrap Gloves – Page 49
Wrap Hats – Page 50
Wrap Kits – Page 34
Wrap Knife – Page 49
Wrap Pro Tuck & Groove Tool Kit – Page 52
Wrap Videos – Page 53

X

Xpert Combo Kit – Page 21
Xpert Corner Rounder Kit – Page 21
Xpert Hole Punch Kit – Page 21
Xtreme Cutting Mats & Grids – Page 26
X-treme HD Aluminum Straight Edge
"Four Pack" Rulers – Page 23
X-treme Stainless Steel Rulers – Page 23
Xtreme Magz – Page 48

Y

Yard Stick Compass Cutter – Page 27

Z

Z-Straps – Page 16



OLMSTED-KIRK
FINE PAPER

MORE INFO:
1-800-367-6526
www.okpaper.com

SOME OF THE PRODUCTS FOR 2017

- MOBILE RACKS
- WALL RACKS
- POD STEAMER
- TWIN WRAP KNIFE
- MANO PRESS
- TABLE FRAMES
- BRACKETS
- CORNER ROUNDER
- HOLE PUNCH TOOL
- WETEDGE SQUEEGEE

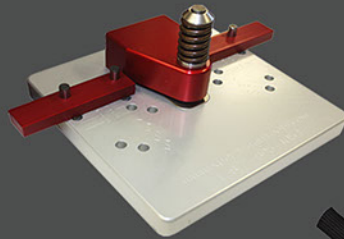
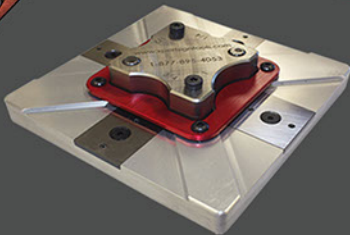
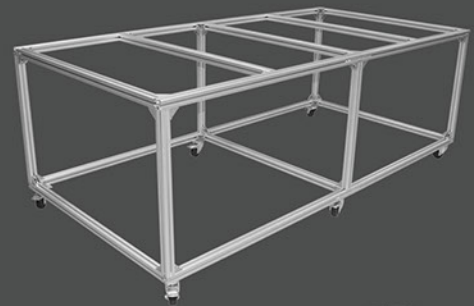
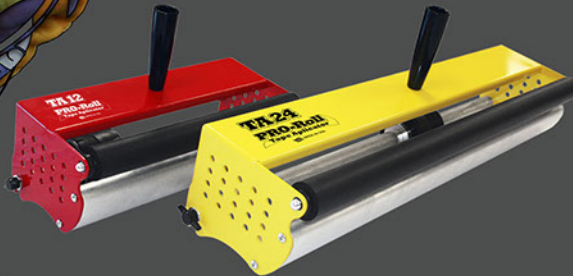

PLACE YOUR ORDER TODAY!

MORE INFO: 1-800-367-6526 • www.okpaper.com